

# brother

Embroidery Design Guide

Stickmuster-Katalog

Guide de motifs de broderie

Borduurontwerpen bedieningshandleiding

Guida ai ricami

Guía de diseños de bordado

Guia de desenho de bordado

Руководство по дизайнам для вышивания

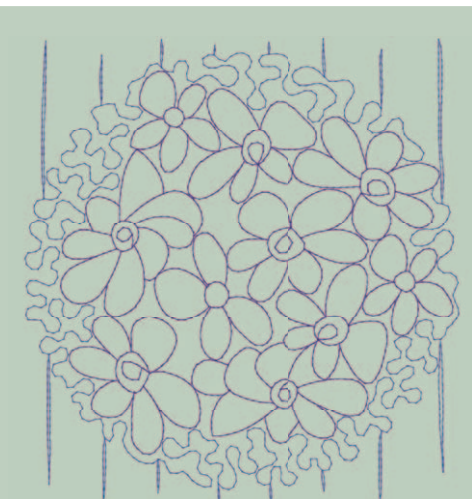
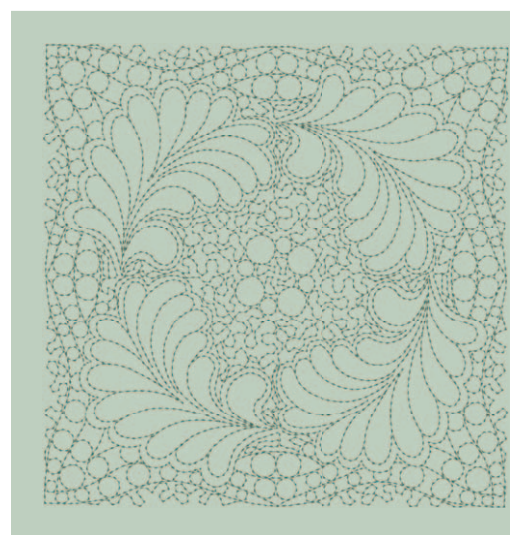

**Note**

The designated embroidery time in this guide is an estimated time only.

**Hinweis**

Die in diesem Stickmuster-Katalog angegebene Stickdauer ist nur ein Schätzwert.

**Remarque**

La durée de broderie indiquée dans ce guide est uniquement une estimation.

**Opmerking**

De aangegeven borduurtijd deze handleiding is slechts een schatting.

**Nota**

Il tempo di ricamo indicato in questa guida è solo una stima.

**Nota**

El tiempo de bordado indicado en esta guía es solo orientativo.

**Nota**

O tempo de bordar indicado neste guia é apenas uma estimativa.

**Примечание**

В настоящем руководстве указано приблизительное время вышивания.

## Contents

- 2 Summary of Embroidery Patterns
- 10 Embroidery Patterns Color Change Table
- 31 Examples of Combinations
- 33 Color Thread Conversion Chart
- 36 Font Name Chart

## Table des matières

- 2 Sommaire des motifs de broderie
- 10 Tableau de changement de couleur des motifs de broderie
- 31 Exemples de combinaisons
- 33 Tableau de conversion des fils de couleur
- 36 Tableau des noms de polices

## Sommario

- 2 Riepilogo dei ricami
- 10 Tabella dei cambi colore dei ricami
- 31 Esempi di combinazioni
- 33 Tabella di conversione dei colori dei filati
- 36 Tabella nomi dei font

## Índice

- 2 Resumo de padrões de bordado
- 10 Tabela de alteração de cor do padrão de bordado
- 31 Exemplos de combinações
- 33 Tabela de conversão das cores de linha
- 36 Quadro de nomes de fontes

## Inhalt

- 2 Übersicht der Stickdesigns
- 10 Stickdesign-Farbtabelle
- 31 Kombinationsbeispiele
- 33 Stickgarn-Farbtabelle
- 36 Tabelle der Schriftarten

## Inhoudsopgave

- 2 Overzicht van de borduurontwerpen
- 10 Kleurenvолgorde voor de borduurontwerpen
- 31 Voorbeelden van combinaties
- 33 Omzettingstabel voor garen kleuren
- 36 Overzicht lettertypen

## Contenido

- 2 Resumen de diseños de bordado
- 10 Tabla de cambios de color para diseños de bordado
- 31 Ejemplos de combinaciones
- 33 Tabla de conversión de hilos de color
- 36 Diagrama de nombre de las fuentes

## Содержание

- 2 Обзор дизайнов для вышивания
- 10 Таблицы цветов нитей для вышивок
- 31 Примеры комбинирования
- 33 Таблица преобразования цветов нитей
- 36 Таблица названий шрифтов

Summary of Embroidery Patterns  
 Sommaire des motifs de broderie  
 Riepilogo dei ricami  
 Resumo de padrões de bordado

Übersicht der Stickdesigns  
 Overzicht van de borduurontwerpen  
 Resumen de diseños de bordado  
 Обзор дизайнов для вышивания

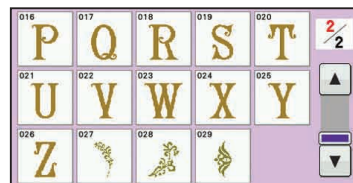
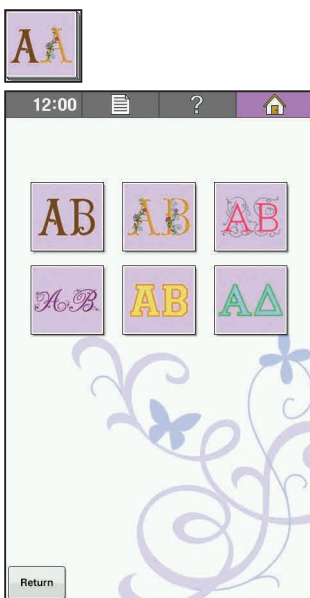
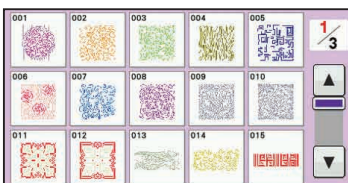
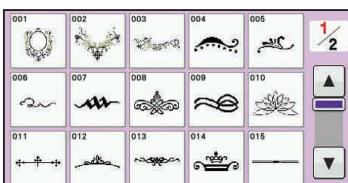
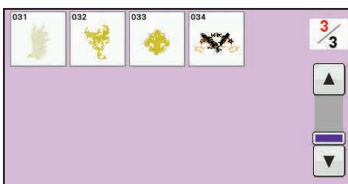
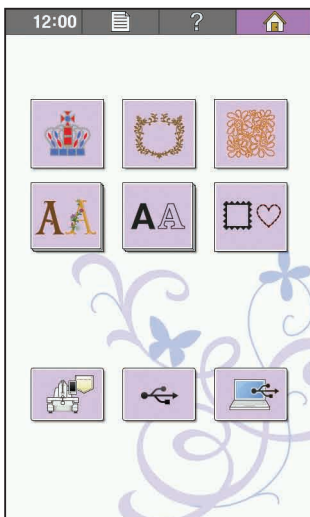

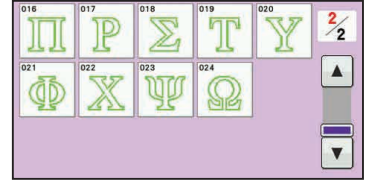
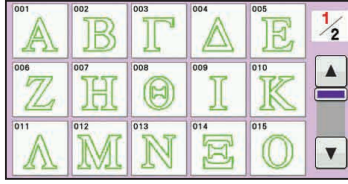
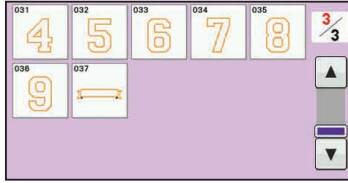
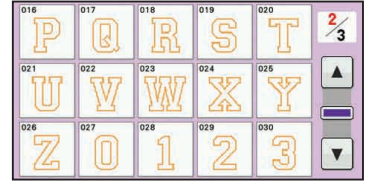
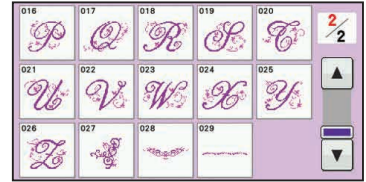
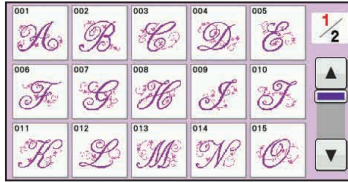
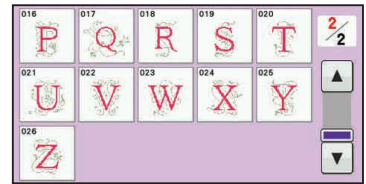
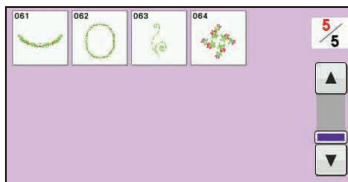



00 *ABC* 1/2

01 **ABC** 02 **ABC** 03 **ABC**

04 *ABC* 05 *ABC* 06 *ABC*

07 **ABC** 08 **ABC** 09 **ABC**

10 **ABC** 11 **ABC** 12 **ABC**

13 **ABC**

14 **ABCD** 15 *ABCD* 16 *ABCD* 2/2

17 *ABCD* 18 **ABB** 19 **ABB**



ABC abc 0-9., &?! **AAa** NNn

*A B C D E F G H* Delete

*I J K L M N O P*

*Q R S T U V W X*

*Y Z -*

ABC **abc** 0-9., &?! **AAa** NNn

*a b c d e f g h* Delete

*i j k l m n o p*

*q r s t u v w x*

*y z -*

ABC abc 0-9., &?! **AAa** NNn

0 1 2 3 4 5 6 7 Delete

8 9 # % \$ £ € ¥

- + \* ÷ = \* . ,

-

ABC abc 0-9., &?! **AAa** NNn

*g ? / @ < > / /* Delete

*/ / / \ ~ : ; ©*

*® ™ “ ” “ ’ ‘ ’*

-

ABC abc 0-9., &?! **AAa** NNn

*A A A B à á â ã* Delete

*ä å æ Ç ç Đ È É*

*Ê Ë è é ê ë Í Î*

*Ï ì í î ï -*

ABC abc 0-9., &?! **AAa** NNn

*N N ñ Ò Ó Ô Õ Ö Ø* Delete

*ò ó ô ö ø õ œ í*

*ı Ů Ů ù ú û ü ž*

*P p ß -*



ABC abc 0-9., &?! **AAa** NNn

**A B C D E F G H** Delete

**I J K L M N O P**

**Q R S T U V W X**

**Y Z -**

ABC **abc** 0-9., &?! **AAa** NNn

**a b c d e f g h** Delete

**i j k l m n o p**

**q r s t u v w x**

**y z -**

ABC abc 0-9., &?! **AAa** NNn

**0 1 2 3 4 5 6 7** Delete

**8 9 # % \$ £ € ¥**

**- + \* ÷ = \* . ,**

-

ABC abc 0-9., &?! **AAa** NNn

**& ? ! @ < > ( )** Delete

**[ ] / \ ~ : ; ©**

**® ™ “ ” “ ’ ‘ ’**

-

ABC abc 0-9., &?! **AAa** NNn

**Â Ã Ä Å Æ à á â ã** Delete

**ä å æ Ç ç Đ È É**

**Ê Ë è é ê ë Í Î**

**Ï ì í î ï -**

ABC abc 0-9., &?! **AAa** NNn

**Ñ Ñ ñ Ô Ö Ø Ó Œ** Delete

**ò ó ô ö ø õ œ í**

**ı Ů Ů ù ú û ü ž**

**P p ß -**



ABC abc 0-9., &?! **AAa** NNn

**A B C D E F G H** Delete

**I J K L M N O P**

**Q R S T U V W X**

**Y Z -**

ABC **abc** 0-9., &?! **AAa** NNn

**a b c d e f g h** Delete

**i j k l m n o p**

**q r s t u v w x**

**y z -**

ABC abc 0-9., &?! **AAa** NNn

**0 1 2 3 4 5 6 7** Delete

**8 9 # % \$ £ € ¥**

**- + \* ÷ = \* . ,**

-

ABC abc 0-9., &?! **AAa** NNn

**& ? ! @ < > ( )** Delete

**[ ] / \ ~ : ; ©**

**® ™ “ ” “ ’ ‘ ’**

-

ABC abc 0-9., &?! **AAa** NNn

**Â Ã Ä Å Æ à á â ã** Delete

**ä å æ Ç ç Đ È É**

**Ê Ë è é ê ë Í Î**

**Ï ì í î ï -**

ABC abc 0-9., &?! **AAa** NNn

**Ñ Ñ ñ Ô Ö Ø Ó Œ** Delete

**ò ó ô ö ø õ œ í**

**ı Ů Ů ù ú û ü ž**

**P p ß -**

Summary of Embroidery Patterns  
 Sommaire des motifs de broderie  
 Riepilogo dei ricami  
 Resumo de padrões de bordado

Übersicht der Stickdesigns  
 Overzicht van de borduurontwerpen  
 Resumen de diseños de bordado  
 Обзор дизайнов для вышивания

03  
ABC

ABC	abc	0-9..	&?!	ÄÄä	ÑÑñ			
A	B	C	D	E	F	G	H	Delete
I	J	K	L	M	N	O	P	
Q	R	S	T	U	V	W	X	
Y	Z	-						

ABC	abc	0-9..	&?!	ÄÄä	ÑÑñ			
a	b	c	d	e	f	g	h	Delete
i	j	k	l	m	n	o	p	
q	r	s	t	u	v	w	x	
y	z	-						

ABC	abc	0-9..	&?!	ÄÄä	ÑÑñ			
0	1	2	3	4	5	6	7	Delete
8	9	#	%	\$	€	£	¥	
-	+	x	÷	=	*	.	,	
-								

ABC	abc	0-9..	&?!	ÄÄä	ÑÑñ			
&	?	!	@	<	>	(	)	Delete
[	]	/	\	~	:	:	©	
®	™	“	”	’	’	’	’	
-								

ABC	abc	0-9..	&?!	ÄÄä	ÑÑñ					
À	Á	Â	Ã	Ä	Å	à	á	â	ã	Delete
ä	å	æ	ç	ç	Ð	È	É			
Ê	Ë	ë	é	ê	ë	Ï	í			
î	ï	ï	ï	ï	ï	ï	ï			

ABC	abc	0-9..	&?!	ÄÄä	ÑÑñ					
Ñ	Ñ	ñ	Ò	Ó	Ô	Õ	Ö	Ï	Delete	
ò	ó	ô	õ	ö	ø	œ	í			
š	š	ŧ	Ũ	Ū	Ů	Ů	Ů			
ü	ž	ƀ	ƀ	ƀ						

04  
ABC

ABC	abc	0-9..	&?!	ÄÄä	ÑÑñ			
A	B	C	D	E	F	G	H	Delete
I	J	K	L	M	N	O	P	
Q	R	S	T	U	V	W	X	
Y	Z	-						

ABC	abc	0-9..	&?!	ÄÄä	ÑÑñ			
a	b	c	d	e	f	g	h	Delete
i	j	k	l	m	n	o	p	
q	r	s	t	u	v	w	x	
y	z	-						

ABC	abc	0-9..	&?!	ÄÄä	ÑÑñ			
0	1	2	3	4	5	6	7	Delete
8	9	#	%	\$	£	€	¥	
-	+	x	÷	=	*	.	,	
-								

ABC	abc	0-9..	&?!	ÄÄä	ÑÑñ			
&	?	!	@	<	>	(	)	Delete
[	]	/	\	~	:	:	©	
®	™	“	”	’	’	’	’	
-								

ABC	abc	0-9..	&?!	ÄÄä	ÑÑñ				
Á	Ā	Ă	Ą	Ȧ	À	á	â	ã	Delete
ä	å	æ	ç	ç	Ð	È	É		
Ê	Ë	ë	é	ê	ë	Ï	í		
î	ï	ï	ï	ï	ï	ï	ï		

ABC	abc	0-9..	&?!	ÄÄä	ÑÑñ				
Ñ	Ñ	ñ	Ò	Ó	Ô	Õ	Ö	Ï	Delete
ò	ó	ô	õ	ö	ø	œ	í		
š	š	ŧ	Ũ	Ū	Ů	Ů	Ů		
ü	ž	ƀ	ƀ	ƀ					

05  
ABC

ABC	abc	0-9..	&?!					
À	Á	Â	Ã	Ä	Å	à	á	Delete
â	ã	ä	å	æ	ç	ç	Ð	
È	É	é	ê	ë	Ï	í		
î	ï	ï	ï	ï	ï	ï	ï	

ABC	abc	0-9..	&?!					
a	b	c	d	e	f	g	h	Delete
i	j	k	l	m	n	o	p	
q	r	s	t	u	v	w	x	
y	z	-						

ABC	abc	0-9..	&?!					
0	1	2	3	4	5	6	7	Delete
8	9	-	=	.	.	-		
-								

ABC	abc	0-9..	&?!					
&	?	!	-	<	>	[	]	Delete
/	\	~	:	:	“	”	’	
’	-							

06  
ABC

ABC	abc	0-9..	&?!	ÄÄä	EEë	ÑÑñ	ŦŦŧ	
À	Á	Â	Ã	Ä	Å	à	á	Delete
I	J	K	L	M	N	O	P	
Q	R	S	T	U	V	W	X	
Y	Z	-						

ABC	abc	0-9..	&?!	ÄÄä	EEë	ÑÑñ	ŦŦŧ	
a	b	c	d	e	f	g	h	Delete
i	j	k	l	m	n	o	p	
q	r	s	t	u	v	w	x	
y	z	-						

ABC	abc	0-9..	&?!	ÄÄä	EEë	ÑÑñ	ŦŦŧ	
0	1	2	3	4	5	6	7	Delete
8	9	#	%	\$	£	€	¥	
-	+	x	÷	=	*	.	,	
-								

ABC	abc	0-9..	&?!	ÄÄä	EEë	ÑÑñ	ŦŦŧ	
È	É	é	ê	ë	Ï	í	ï	Delete
ì	í	î	ï	ï	ï	ï	ï	
Ĉ	Ĉ	ĉ	ĉ	ĉ	Đ	Đ	đ	
-								

ABC	abc	0-9..	&?!	ÄÄä	EEë	ÑÑñ	ŦŦŧ	
À	Á	Â	Ã	Ä	Å	à	á	Delete
ä	å	æ	ç	ç	Ð	È	É	
Ê	Ë	ë	é	ê	ë	Ï	í	
î	ï	ï	ï	ï	ï	ï	ï	

ABC	abc	0-9..	&?!	ÄÄä	EEë	ÑÑñ	ŦŦŧ	
È	É	é	ê	ë	Ï	í	ï	Delete
ì	í	î	ï	ï	ï	ï	ï	
Ĉ	Ĉ	ĉ	ĉ	ĉ	Đ	Đ	đ	
-								

ABC	abc	0-9..	&?!	ÄÄä	ÉÉé	ÑÑñ	ŦŦŧ
Ŧ	Ŧ	Ŧ	ñ	ñ	ñ	Ŧ	Ŧ
Ŧ	Ŧ	Ŧ	Ŧ	Ŧ	Ŧ	Ŧ	Ŧ
Ŧ	Ŧ	Ŧ	Ŧ	Ŧ	Ŧ	Ŧ	Ŧ
Ŧ	Ŧ	Ŧ	Ŧ	Ŧ	Ŧ	Ŧ	Ŧ

ABC	abc	0-9..	&?!	ÄÄä	ÉÉé	ÑÑñ	ŦŦŧ
Ŧ	Ŧ	Ŧ	Ŧ	Ŧ	Ŧ	Ŧ	Ŧ
Ŧ	Ŧ	Ŧ	Ŧ	Ŧ	Ŧ	Ŧ	Ŧ
Ŧ	Ŧ	Ŧ	Ŧ	Ŧ	Ŧ	Ŧ	Ŧ
Ŧ	Ŧ	Ŧ	Ŧ	Ŧ	Ŧ	Ŧ	Ŧ

07 ABC

ABC	abc	0-9..	&?!	ÄÄä	ÑÑñ		
A	B	C	D	E	F	G	H
I	J	K	L	M	N	O	P
Q	R	S	T	U	V	W	X
Y	Z	-					

ABC	abc	0-9..	&?!	ÄÄä	ÑÑñ		
a	b	c	d	e	f	g	h
i	j	k	l	m	n	o	p
q	r	s	t	u	v	w	x
y	z	-					

ABC	abc	0-9..	&?!	ÄÄä	ÑÑñ		
0	1	2	3	4	5	6	7
8	9	#	%	\$	£	€	¥
-	+	x	÷	=	*	.	,
-							

08 ABC

ABC	abc	0-9..	&?!	ÄÄä	ÑÑñ		
&	?	!	@	<	>	(	)
[	]	/	\	~	:	;	©
®	™	"	"	"	'	'	'
-							

ABC	abc	0-9..	&?!	ÄÄä	ÑÑñ		
Á	À	À	Æ	à	á	â	ã
ä	å	æ	ç	ç	ð	è	é
ê	ë	é	é	ê	ë	î	ï
ì	í	ì	ì	ì	ì	ì	ì

ABC	abc	0-9..	&?!	ÄÄä	ÑÑñ		
Ŧ	Ŧ	ñ	Ŧ	Ŧ	Ŧ	Ŧ	Ŧ
Ŧ	Ŧ	Ŧ	Ŧ	Ŧ	Ŧ	Ŧ	Ŧ
Ŧ	Ŧ	Ŧ	Ŧ	Ŧ	Ŧ	Ŧ	Ŧ
Ŧ	Ŧ	Ŧ	Ŧ	Ŧ	Ŧ	Ŧ	Ŧ

ABC	abc	0-9..	&?!	ÄÄä	ÑÑñ		
A	B	C	D	E	F	G	H
I	J	K	L	M	N	O	P
Q	R	S	T	U	V	W	X
Y	Z	-					

ABC	abc	0-9..	&?!	ÄÄä	ÑÑñ		
a	b	c	d	e	f	g	h
i	j	k	l	m	n	o	p
q	r	s	t	u	v	w	x
y	z	-					

ABC	abc	0-9..	&?!	ÄÄä	ÑÑñ		
0	1	2	3	4	5	6	7
8	9	#	%	\$	£	€	¥
-	+	x	÷	=	*	.	,
-							

09 ABC

ABC	abc	0-9..	&?!	ÄÄä	ÑÑñ		
&	?	!	@	<	>	(	)
[	]	/	\	~	:	;	©
®	™	"	"	"	'	'	'
-							

ABC	abc	0-9..	&?!	ÄÄä	ÑÑñ		
À	À	À	Æ	à	á	â	ã
ä	å	æ	ç	ç	ð	è	é
ê	ë	é	é	ê	ë	î	ï
ì	í	ì	ì	ì	ì	ì	ì

ABC	abc	0-9..	&?!	ÄÄä	ÑÑñ		
Ŧ	Ŧ	ñ	Ŧ	Ŧ	Ŧ	Ŧ	Ŧ
Ŧ	Ŧ	Ŧ	Ŧ	Ŧ	Ŧ	Ŧ	Ŧ
Ŧ	Ŧ	Ŧ	Ŧ	Ŧ	Ŧ	Ŧ	Ŧ
Ŧ	Ŧ	Ŧ	Ŧ	Ŧ	Ŧ	Ŧ	Ŧ

ABC	abc	0-9..	&?!	ÄÄä	ÑÑñ		
A	B	C	D	E	F	G	H
I	J	K	L	M	N	O	P
Q	R	S	T	U	V	W	X
Y	Z	-					

ABC	abc	0-9..	&?!	ÄÄä	ÑÑñ		
a	b	c	d	e	f	g	h
i	j	k	l	m	n	o	p
q	r	s	t	u	v	w	x
y	z	-					

ABC	abc	0-9..	&?!	ÄÄä	ÑÑñ		
0	1	2	3	4	5	6	7
8	9	#	%	\$	£	€	¥
-	+	x	÷	=	*	.	,
-							

ABC	abc	0-9..	&?!	ÄÄä	ÑÑñ		
&	?	!	@	<	>	(	)
[	]	/	\	~	:	;	©
®	™	"	"	"	'	'	'
-							

ABC	abc	0-9..	&?!	ÄÄä	ÑÑñ		
À	À	À	Æ	à	á	â	ã
ä	å	æ	ç	ç	ð	è	é
ê	ë	é	é	ê	ë	î	ï
ì	í	ì	ì	ì	ì	ì	ì

ABC	abc	0-9..	&?!	ÄÄä	ÑÑñ		
Ŧ	Ŧ	ñ	Ŧ	Ŧ	Ŧ	Ŧ	Ŧ
Ŧ	Ŧ	Ŧ	Ŧ	Ŧ	Ŧ	Ŧ	Ŧ
Ŧ	Ŧ	Ŧ	Ŧ	Ŧ	Ŧ	Ŧ	Ŧ
Ŧ	Ŧ	Ŧ	Ŧ	Ŧ	Ŧ	Ŧ	Ŧ

10 ABC

ABC	abc	0-9..	&?!	ÄÄä	ÑÑñ		
A	B	C	D	E	F	G	H
I	J	K	L	M	N	O	P
Q	R	S	T	U	V	W	X
Y	Z	-					

ABC	abc	0-9..	&?!	ÄÄä	ÑÑñ		
a	b	c	d	e	f	g	h
i	j	k	l	m	n	o	p
q	r	s	t	u	v	w	x
y	z	-					

ABC	abc	0-9..	&?!	ÄÄä	ÑÑñ		
0	1	2	3	4	5	6	7
8	9	#	%	\$	£	€	¥
-	+	x	÷	=	*	.	,
-							



Summary of Embroidery Patterns  
 Sommaire des motifs de broderie  
 Riepilogo dei ricami  
 Resumo de padrões de bordado

Übersicht der Stickdesigns  
 Overzicht van de borduurontwerpen  
 Resumen de diseños de bordado  
 Обзор дизайнов для вышивания

11 ABC

ABC	abc	0-9..	&?!	ÄÄä	ÑÑñ	
&	?	!	@	<	>	( )
[	]	/	\	~	:	; ©
®	™	“	”	’	‘	’
Delete						

ABC	abc	0-9..	&?!	ÄÄä	ÑÑñ	
À	Á	Â	Æ	à	á	â
ä	å	æ	ç	ç	ð	è
é	ë	è	é	ê	ë	ğ
í	ï	ì	í	î	ï	ı
Delete						

ABC	abc	0-9..	&?!	ÄÄä	ÑÑñ	
Ń	Ň	ň	Ō	Ŏ	ø	Œ
ò	ó	ô	ö	ø	õ	œ
ş	ş	ı	û	ü	ù	ú
ü	ž	Ʒ	Ʒ	Ʒ	Ʒ	Ʒ
Delete						

ABC	abc	0-9..	&?!	ÄÄä	ÑÑñ	
A	B	C	D	E	F	G
I	J	K	L	M	N	O
Q	R	S	T	U	V	W
Y	Z	-	Delete			

ABC	abc	0-9..	&?!	ÄÄä	ÑÑñ	
a	b	c	d	e	f	g
i	j	k	l	m	n	o
q	r	s	t	u	v	w
y	z	-	Delete			

ABC	abc	0-9..	&?!	ÄÄä	ÑÑñ	
0	1	2	3	4	5	6
8	9	#	%	\$	£	¥
-	+	x	÷	=	*	.
Delete						

12 ABC

ABC	abc	0-9..	&?!	ÄÄä	ÑÑñ	
&	?	!	@	<	>	( )
[	]	/	\	~	:	; ©
®	™	“	”	’	‘	’
Delete						

ABC	abc	0-9..	&?!	ÄÄä	ÑÑñ	
À	Á	Â	Æ	à	á	â
ä	å	æ	ç	ç	ð	è
é	ë	è	é	ê	ë	ğ
í	ï	ì	í	î	ï	ı
Delete						

ABC	abc	0-9..	&?!	ÄÄä	ÑÑñ	
Ń	Ň	ň	Ō	Ŏ	ø	Œ
ò	ó	ô	ö	ø	õ	œ
ş	ş	ı	û	ü	ù	ú
ü	ž	Ʒ	Ʒ	Ʒ	Ʒ	Ʒ
Delete						

ABC	abc	0-9..	&?!	ÄÄä	ÑÑñ	
A	B	C	D	E	F	G
I	J	K	L	M	N	O
Q	R	S	T	U	V	W
Y	Z	-	Delete			

ABC	abc	0-9..	&?!	ÄÄä	ÑÑñ	
a	b	c	d	e	f	g
i	j	k	l	m	n	o
q	r	s	t	u	v	w
y	z	-	Delete			

ABC	abc	0-9..	&?!	ÄÄä	ÑÑñ	
0	1	2	3	4	5	6
8	9	#	%	\$	£	¥
-	+	x	÷	=	*	.
Delete						

13 ABC

ABC	abc	0-9..	&?!	ÄÄä	ÑÑñ	
&	?	!	@	<	>	( )
[	]	/	\	~	:	; ©
®	™	“	”	’	‘	’
Delete						

ABC	abc	0-9..	&?!	ÄÄä	ÑÑñ	
À	Á	Â	Æ	à	á	â
ä	å	æ	ç	ç	ð	è
é	ë	è	é	ê	ë	ğ
í	ï	ì	í	î	ï	ı
Delete						

ABC	abc	0-9..	&?!	ÄÄä	ÑÑñ	
Ń	Ň	ň	Ō	Ŏ	ø	Œ
ò	ó	ô	ö	ø	õ	œ
ş	ş	ı	û	ü	ù	ú
ü	ž	Ʒ	Ʒ	Ʒ	Ʒ	Ʒ
Delete						

ABC	abc	0-9..	&?!	ÄÄä	ÑÑñ	
A	B	C	D	E	F	G
I	J	K	L	M	N	O
Q	R	S	T	U	V	W
Y	Z	-	Delete			

ABC	abc	0-9..	&?!	ÄÄä	ÑÑñ	
a	b	c	d	e	f	g
i	j	k	l	m	n	o
q	r	s	t	u	v	w
y	z	-	Delete			

ABC	abc	0-9..	&?!	ÄÄä	ÑÑñ	
0	1	2	3	4	5	6
8	9	#	%	\$	£	¥
-	+	x	÷	=	*	.
Delete						

14 ABCD

ABC	abc	0-9..	&?!	ÄÄä	ÑÑñ	
&	?	!	@	<	>	( )
[	]	/	\	~	:	; ©
®	™	“	”	’	‘	’
Delete						

ABC	abc	0-9..	&?!	ÄÄä	ÑÑñ	
À	Á	Â	Æ	à	á	â
ä	å	æ	ç	ç	ð	è
é	ë	è	é	ê	ë	ğ
í	ï	ì	í	î	ï	ı
Delete						

ABC	abc	0-9..	&?!	ÄÄä	ÑÑñ	
Ń	Ň	ň	Ō	Ŏ	ø	Œ
ò	ó	ô	ö	ø	õ	œ
ş	ş	ı	û	ü	ù	ú
ü	ž	Ʒ	Ʒ	Ʒ	Ʒ	Ʒ
Delete						

ABC	abc	0-9..	&?!	ÄÄä	ÑÑñ	
A	B	C	D	E	F	G
I	J	K	L	M	N	O
Q	R	S	T	U	V	W
Y	Z	-	Delete			

ABC	abc	0-9..	&?!	ÄÄä	ÑÑñ	
a	b	c	d	e	f	g
i	j	k	l	m	n	o
q	r	s	t	u	v	w
y	z	-	Delete			

ABC	abc	0-9..	&?!	ÄÄä	ÑÑñ	
0	1	2	3	4	5	6
8	9	#	%	\$	£	¥
-	+	x	÷	=	*	.
Delete						

ABC	abc	0-9,.	&?! <b></b>	ÄÄä	ÑÑñ			
&	?	!	@	<	>	(	)	Delete
[	]	/	\	~	:	;	©	
®	™	“	”	”	’	’	’	
—								↵

ABC	abc	0-9,.	&?! <b></b>	ÄÄä	ÑÑñ				
À	Á	Â	Æ	à	á	â	ä	Delete	
ä	å	æ	Ç	ç	Ð	È	É		
Ê	Ë	è	é	ê	ë	Ï	ì		
ì	í	î	—						↵

ABC	abc	0-9,.	&?! <b></b>	ÄÄä	ÑÑñ				
Ñ	Ń	ñ	Ô	Õ	Ø	Ó	Œ	Delete	
ò	ó	ô	ö	ø	õ	œ	í		
ƒ	Û	Ü	ù	ú	û	ü	ž		
Ɔ	Ɔ	β	—						↵

15  
ABCD

ABC	abc	0-9,.	&?! <b></b>	ÄÄä	ÑÑñ			
A	B	C	D	E	F	G	H	Delete
I	J	K	L	M	N	O	P	
Q	R	S	T	U	V	W	X	
Y	Z	—						↵

ABC	abc	0-9,.	&?! <b></b>	ÄÄä	ÑÑñ			
a	h	c	d	e	f	g	h	Delete
i	j	k	l	m	n	a	p	
q	r	a	t	u	a	u	x	
y	z	—						↵

ABC	abc	0-9,.	&?! <b></b>	ÄÄä	ÑÑñ			
0	1	2	3	4	5	6	7	Delete
8	9	-	.	,	—			
								↵

ABC	abc	0-9,.	&?! <b></b>	ÄÄä	ÑÑñ			
&	?	!	@	(	)	/	'	Delete
—								↵

ABC	abc	0-9,.	&?! <b></b>	ÄÄä	ÑÑñ				
Á	À	À	Æ	à	á	â	ä	Delete	
ä	æ	Ç	ç	è	é	ê	ë		
ì	í	î	—						↵

ABC	abc	0-9,.	&?! <b></b>	ÄÄä	ÑÑñ			
Ñ	ñ	Œ	Ø	à	á	â	ä	Delete
ø	Û	ù	ú	û	ü	β	—	
								↵

16  
ABCD

ABC	abc	0-9,.	&?! <b></b>	ÄÄä	ÑÑñ			
À	B	C	D	E	F	G	H	Delete
I	J	K	L	M	N	O	P	
Q	R	S	T	U	V	W	X	
Y	Z	—						↵

ABC	abc	0-9,.	&?! <b></b>	ÄÄä	ÑÑñ			
a	b	c	d	e	f	g	h	Delete
i	j	k	l	m	n	o	p	
q	r	s	t	u	v	w	x	
y	z	—						↵

ABC	abc	0-9,.	&?! <b></b>	ÄÄä	ÑÑñ			
0	1	2	3	4	5	6	7	Delete
8	9	-	.	,	—			
								↵

ABC	abc	0-9,.	&?! <b></b>	ÄÄä	ÑÑñ			
&	?	!	@	(	)	/	'	Delete
—								↵

ABC	abc	0-9,.	&?! <b></b>	ÄÄä	ÑÑñ				
À	À	À	Æ	à	á	â	ä	Delete	
ä	æ	Ç	ç	è	é	ê	ë		
ì	í	î	—						↵

ABC	abc	0-9,.	&?! <b></b>	ÄÄä	ÑÑñ			
Ñ	ñ	Œ	Ø	à	á	â	ä	Delete
ø	Û	ù	ú	û	ü	β	—	
								↵

17  
ABCD

ABC	abc	0-9,.	&?! <b></b>	ÄÄä	ÑÑñ			
À	B	C	D	E	F	G	H	Delete
I	J	K	L	M	N	O	P	
Q	R	S	T	U	V	W	X	
Y	Z	—						↵

ABC	abc	0-9,.	&?! <b></b>	ÄÄä	ÑÑñ			
a	b	c	d	e	f	g	h	Delete
i	j	k	l	m	n	o	p	
q	r	s	t	u	v	w	x	
y	z	—						↵

ABC	abc	0-9,.	&?! <b></b>	ÄÄä	ÑÑñ			
0	1	2	3	4	5	6	7	Delete
8	9	-	.	,	—			
								↵

ABC	abc	0-9,.	&?! <b></b>	ÄÄä	ÑÑñ			
&	?	!	@	(	)	/	'	Delete
—								↵

ABC	abc	0-9,.	&?! <b></b>	ÄÄä	ÑÑñ				
À	À	À	Æ	à	á	â	ä	Delete	
ä	æ	Ç	ç	è	é	ê	ë		
ì	í	î	—						↵

ABC	abc	0-9,.	&?! <b></b>	ÄÄä	ÑÑñ			
Ñ	ñ	Œ	Ø	à	á	â	ä	Delete
ø	Û	ù	ú	û	ü	β	—	
								↵

18  
ABВ

ABВ	ЧШЩ	абв	чшщ					
А	Б	В	Г	Д	Е	Ё	Ж	Delete
З	И	Й	К	Л	М	Н	О	
П	Р	С	Т	У	Ф	Х	Ц	
—								↵

ABВ	ЧШЩ	абв	чшщ					
Ч	Ш	Щ	Ъ	Ы	Ь	Э	Ю	Delete
Я	Г	Є	І	Ї	Ў	Ҁ	ҁ	
Ј	Љ	Њ	Џ	Ѓ	Ѕ	Ї	—	
								↵

ABВ	ЧШЩ	абв	чшщ					
а	б	в	г	д	е	ё	ж	Delete
з	и	й	к	л	м	н	о	
п	р	с	т	у	ф	х	ц	
—								↵

Summary of Embroidery Patterns  
 Sommaire des motifs de broderie  
 Riepilogo dei ricami  
 Resumo de padrões de bordado

Übersicht der Stickdesigns  
 Overzicht van de borduurontwerpen  
 Resumen de diseños de bordado  
 Обзор дизайнов для вышивания



19 АБВ

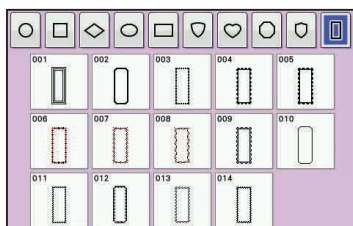
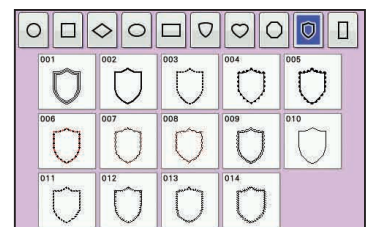
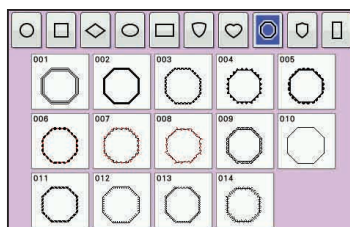
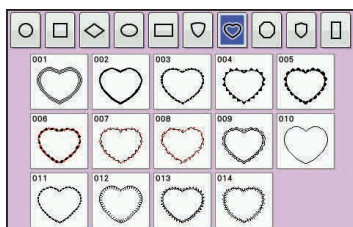
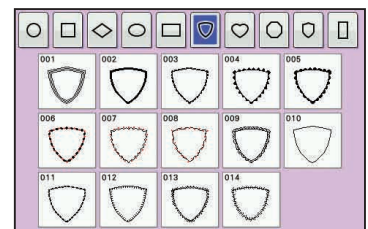
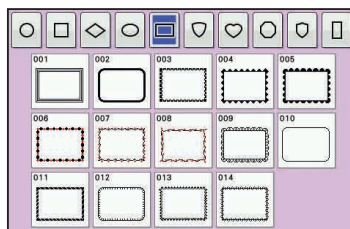
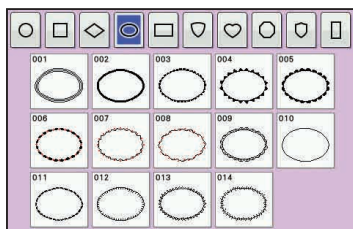
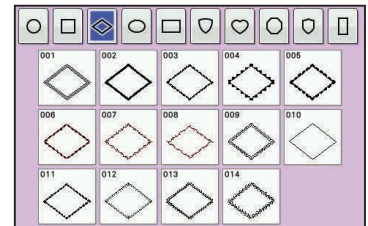
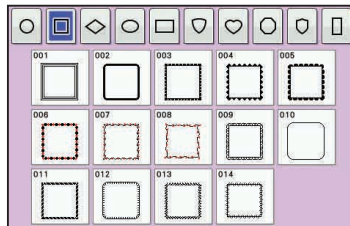
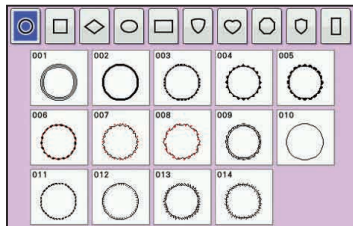

# Embroidery Patterns Color Change Table

## Tableau de changement de couleur des motifs de broderie

## Tabella dei cambi colore dei ricami

## Tabela de alteração de cor do padrão de bordado

# Stickdesign-Farbtabelle

## Kleurenvolgorde voor de borduurontwerpen

## Tabla de cambios de color para diseños de bordado

## Таблицы цветов нитей для вышивок

- ✂ Embroidery patterns
- ✂ Motifs de broderie
- ✂ Ricami
- ✂ Padrões de bordado

- ✂ Stickdesigns
- ✂ Borduurontwerpen
- ✂ Diseños de bordado
- ✂ Дизайны для вышивания



**No.1** **4 min**

1	(107)
2	(007)
3	(005)
4	(007)
5	(107)

Order to embroider  
Stickreihenfolge  
Séquence de broderie  
Borduurvolgorde  
Sequenza dei cambi colore del ricamo  
Orden para el bordador  
Ordem para bordar  
Порядок вышивания

Embroidery thread color  
Stickgarnfarbe  
Couleur du fil de broderie  
Kleur borduurgaren  
Colore filo ricamo  
Color del hilo de bordado  
Cor da linha de bordar  
Цвет нити для вышивания

Time required for embroidering  
Stickdauer  
Durée requise pour broder  
Tijd benodigd voor het borduren  
Tempo di ricamo necessario  
Tiempo requerido para el bordado  
Tempo necessário para bordar  
Время, необходимое для вышивания

Embroidery thread color number  
Stickgarn-Farbnummer  
Numéro de couleur du fil de broderie  
Kleurnummer borduurgaren  
Numero del colore del filo da ricamo  
Número de color del hilo de bordado  
Número da cor da linha de bordar  
Номер цвета нити для вышивания

Embroidery size  
Größe der Stickerei  
Taille de la broderie  
Afmeting borduurmotief  
Dimensioni del ricamo  
Tecla de tamaño  
Tamanho do bordado  
Размер вышивки

40.1 mm  
41.3 mm

Time required for embroidering  
Stickdauer  
Durée requise pour broder  
Tijd benodigd voor het borduren  
Tempo di ricamo necessario  
Tiempo requerido para el bordado  
Tempo necessário para bordar  
Время, необходимое для вышивания

Embroidery thread color number  
Stickgarn-Farbnummer  
Numéro de couleur du fil de broderie  
Kleurnummer borduurgaren  
Numero del colore del filo da ricamo  
Número de color del hilo de bordado  
Número da cor da linha de bordar  
Номер цвета нити для вышивания

Embroidery size  
Größe der Stickerei  
Taille de la broderie  
Afmeting borduurmotief  
Dimensioni del ricamo  
Tecla de tamaño  
Tamanho do bordado  
Размер вышивки



**No.13** **2 min**

1	(214)
---	-------

39.3 mm  
38.4 mm



**No.14** **5 min**

1	(214)
---	-------

68.5 mm  
69.5 mm



**No.15** **4 min**

1	(348)
2	(399)
3	(085)
4	(124)

41.4 mm  
49.3 mm

**No.2** **2 min**

1	(812)
2	(205)

32.1 mm  
30.2 mm

**No.6** **1 min**

1	(399)
2	(348)

31.2 mm  
21.1 mm

**No.10** **2 min**

1	(348)
2	(001)
3	(517)
4	(515)
5	(323)
6	(058)
7	(214)
8	(208)

30.8 mm  
27.6 mm



**No.16** **12 min**

1	(348)
2	(124)
3	(085)
4	(399)

88.1 mm  
157.9 mm

**No.3** **1 min**

1	(612)
2	(515)
3	(534)
4	(620)

28.2 mm  
27.4 mm

**No.7** **1 min**

1	(328)
2	(214)

37.6 mm  
15.3 mm

**No.11** **2 min**

1	(001)
2	(515)
3	(800)
4	(214)
5	(001)

31.0 mm  
30.9 mm

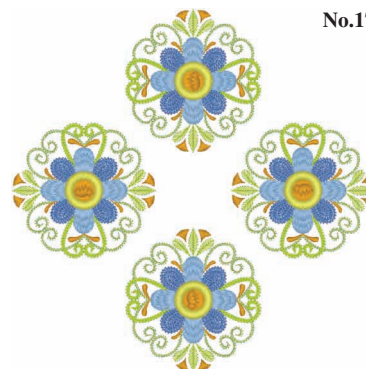

**No.17** **38 min**

1	(517)
2	(214)
3	(513)
4	(070)
5	(607)
6	(214)
7	(206)

192.5 mm  
192.5 mm

**No.4** **1 min**

1	(079)
2	(001)
3	(058)

19.1 mm  
29.3 mm

**No.8** **1 min**

1	(001)
2	(509)
3	(058)

29.9 mm  
23.8 mm

**No.5** **1 min**

1	(509)
2	(515)

26.3 mm  
26.6 mm

**No.9** **1 min**

1	(900)
2	(800)
3	(900)

15.0 mm  
16.1 mm

**No.12** **7 min**

1	(005)
---	-------

68.2 mm  
53.8 mm

**No.18** **36 min**

1	(399)
2	(517)
3	(607)
4	(070)
5	(804)
6	(613)
7	(214)
8	(399)
9	(517)
10	(607)
11	(070)
12	(804)
13	(613)
14	(214)

↓ 185.9 mm  
 ↔ 185.9 mm

**No.21** **35 min**

1	(612)	7	(542)
2	(405)	8	(405)
3	(542)	9	(019)
4	(001)	10	(001)
5	(019)	11	(070)
6	(405)		

↓ 153.0 mm ↔ 153.5 mm

**No.22**

**No.19** **28 min**

1	(513)
2	(085)
3	(807)
4	(507)
5	(209)
6	(206)
7	(807)

↓ 177.3 mm  
 ↔ 177.4 mm

**50 min**

1	(515)	15	(019)	29	(010)	43	(208)	57	(513)
2	(027)	16	(208)	30	(323)	44	(843)	58	(534)
3	(513)	17	(843)	31	(513)	45	(010)	59	(707)
4	(058)	18	(010)	32	(534)	46	(810)	60	(208)
5	(208)	19	(810)	33	(019)	47	(010)	61	(513)
6	(070)	20	(010)	34	(208)	48	(323)	62	(515)
7	(019)	21	(323)	35	(843)	49	(070)	63	(027)
8	(209)	22	(513)	36	(010)	50	(208)	64	(513)
9	(208)	23	(534)	37	(810)	51	(001)	65	(058)
10	(800)	24	(019)	38	(010)	52	(058)	66	(208)
11	(405)	25	(208)	39	(323)	53	(010)	67	(070)
12	(058)	26	(843)	40	(513)	54	(070)	68	(019)
13	(513)	27	(010)	41	(534)	55	(058)		
14	(534)	28	(810)	42	(019)	56	(620)		

↓ 195.8 mm ↔ 195.8 mm

**No.20** **41 min**

1	(613)
2	(001)
3	(086)
4	(542)
5	(613)
6	(001)
7	(086)
8	(542)
9	(613)
10	(001)
11	(086)
12	(542)
13	(613)
14	(001)
15	(086)
16	(542)

↓ 194.0 mm  
 ↔ 194.0 mm

**No.23** **36 min**

1	(804)
2	(810)
3	(607)
4	(017)
5	(019)
6	(085)
7	(086)
8	(027)
9	(124)

↓ 156.0 mm  
 ↔ 155.1 mm



**No.24**      **22 min**

1	(107)
2	(086)
↕	148.2 mm
↔	195.4 mm



**No.25**      **21 min**

1	(405)
2	(420)
↕	148.2 mm
↔	195.4 mm



**No.26**      **22 min**

1	(517)
2	(515)
↕	148.2 mm
↔	195.4 mm



**No.27**      **21 min**

1	(007)
2	(405)
↕	148.2 mm
↔	195.4 mm



**No.28**      **56 min**

1	(208)	12	(307)
2	(323)	13	(126)
3	(126)	14	(333)
4	(058)	15	(208)
5	(800)	16	(126)
6	(107)	17	(001)
7	(058)	18	(800)
8	(001)	19	(058)
9	(126)	20	(107)
10	(399)	21	(399)
11	(107)	22	(058)
↕ 194.3 mm ↔ 145.3 mm			



**No.29**      **46 min**

1	(208)
2	(900)
3	(620)
4	(339)
5	(900)
↕	182.7 mm
↔	194.7 mm



**No.30**      **51 min**

1	(420)
2	(515)
3	(206)
4	(420)
5	(007)
6	(800)
7	(515)
8	(206)
9	(007)
10	(005)
11	(420)
12	(800)
↕	192.2 mm
↔	184.1 mm



**No.31**      **10 min**

1	(399)
2	(001)
↕	85.5 mm
↔	56.0 mm



**No.32**      **4 min**

1	(328)
↕	74.1 mm
↔	54.1 mm



**No.33**      **2 min**

1	(328)
2	(348)
↕	42.4 mm
↔	40.1 mm



**No.34**      **11 min**

1	(209)	6	(339)
2	(206)	7	(323)
3	(209)	8	(001)
4	(900)	9	(843)
5	(206)	10	(900)
↕ 55.2 mm ↔ 118.9 mm			

- ❖ Decoration/Hallmark patterns
- ❖ Motifs de décoration/d'emblème
- ❖ Ricami Decorazione/Stemma
- ❖ Desenhos decorativos/molduras e símbolos

- ❖ Dekor-/Ornamentmuster
- ❖ Ornamenten en decoratieve ontwerpen
- ❖ Diseños ornamentales/de marcos decorativos
- ❖ Декоративные/традиционные дизайны

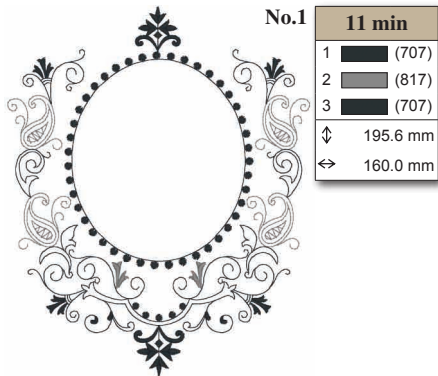

<b>No.1</b>	<b>11 min</b>
1	█ (707)
2	█ (817)
3	█ (707)
↓	195.6 mm
↔	160.0 mm



<b>No.7</b>	<b>1 min</b>
1	█ (900)
↓	18.9 mm
↔	62.7 mm

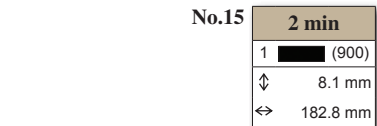

<b>No.15</b>	<b>2 min</b>
1	█ (900)
↓	8.1 mm
↔	182.8 mm



<b>No.2</b>	<b>4 min</b>
1	█ (817)
2	█ (707)
↓	81.8 mm
↔	111.8 mm



<b>No.8</b>	<b>5 min</b>
1	█ (900)
↓	62.4 mm
↔	123.6 mm



<b>No.16</b>	<b>20 min</b>
1	█ (399)
2	█ (804)
↓	186.8 mm
↔	160.1 mm



<b>No.3</b>	<b>3 min</b>
1	█ (707)
2	█ (817)
↓	39.4 mm
↔	136.7 mm



<b>No.9</b>	<b>1 min</b>
1	█ (900)
↓	23.8 mm
↔	58.5 mm

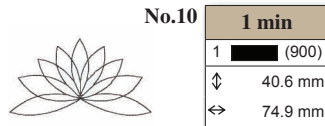

<b>No.10</b>	<b>1 min</b>
1	█ (900)
↓	40.6 mm
↔	74.9 mm

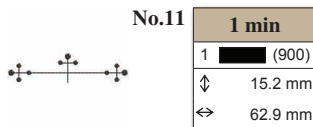

<b>No.11</b>	<b>1 min</b>
1	█ (900)
↓	15.2 mm
↔	62.9 mm

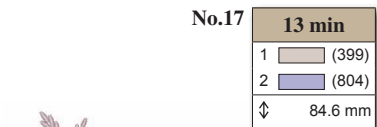

<b>No.17</b>	<b>13 min</b>
1	█ (399)
2	█ (804)
↓	84.6 mm
↔	143.0 mm



<b>No.4</b>	<b>2 min</b>
1	█ (900)
↓	25.0 mm
↔	69.8 mm



<b>No.12</b>	<b>3 min</b>
1	█ (900)
↓	37.8 mm
↔	125.4 mm



<b>No.5</b>	<b>2 min</b>
1	█ (900)
↓	40.5 mm
↔	90.3 mm



<b>No.13</b>	<b>3 min</b>
1	█ (900)
↓	24.7 mm
↔	129.1 mm



<b>No.18</b>	<b>10 min</b>
1	█ (399)
2	█ (804)
↓	48.4 mm
↔	188.5 mm



<b>No.6</b>	<b>1 min</b>
1	█ (900)
↓	24.4 mm
↔	95.7 mm

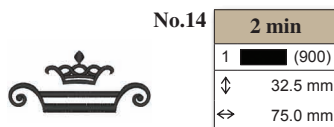

<b>No.14</b>	<b>2 min</b>
1	█ (900)
↓	32.5 mm
↔	75.0 mm





**No.19**

<b>19 min</b>	
1	(328)
↕	173.7 mm
↔	194.4 mm



**No.24**

<b>2 min</b>	
1	(328)
↕	47.9 mm
↔	51.4 mm



**No.25**

<b>1 min</b>	
1	(869)
↕	26.0 mm
↔	57.0 mm



**No.20**

<b>13 min</b>	
1	(328)
↕	137.6 mm
↔	147.2 mm



**No.26**

<b>2 min</b>	
1	(007)
↕	16.8 mm
↔	92.6 mm



**No.21**

<b>24 min</b>	
1	(704)
↕	154.3 mm
↔	186.5 mm



**No.27**

<b>1 min</b>	
1	(005)
↕	20.7 mm
↔	33.7 mm



**No.22**

<b>7 min</b>	
1	(900)
2	(085)
3	(086)
4	(807)
↕	47.9 mm
↔	161.3 mm

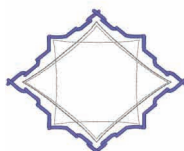

**No.23**

<b>4 min</b>	
1	(005)
2	(817)
3	(607)
↕	77.3 mm
↔	95.1 mm



- ❖ Quilt patterns
- ❖ Motifs pour quilting (courtepointe)
- ❖ Ricami per quilting
- ❖ Desenhos de acolchoados

- ❖ Quilt-Stickmuster
- ❖ Quiltontwerpen
- ❖ Diseños de acolchado
- ❖ Дизайны для квилтинга

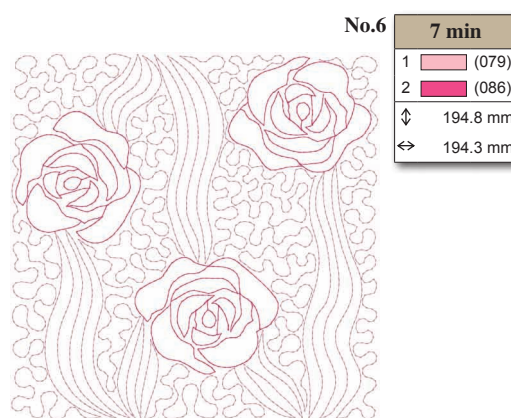
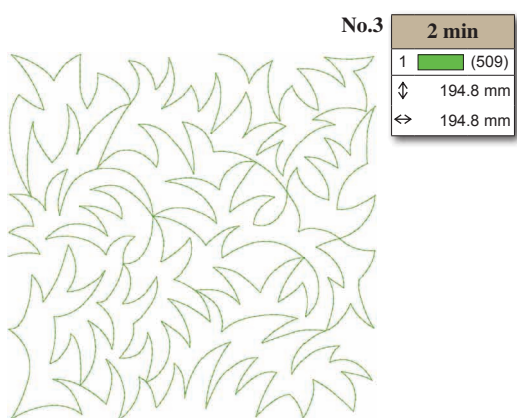
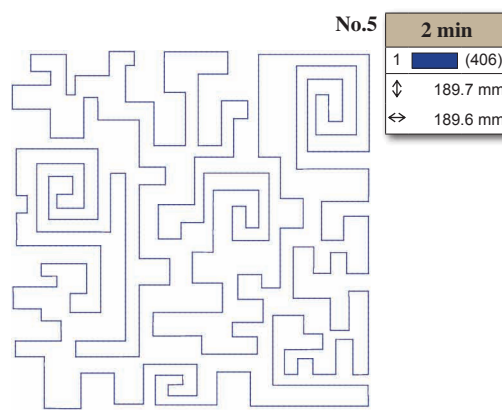
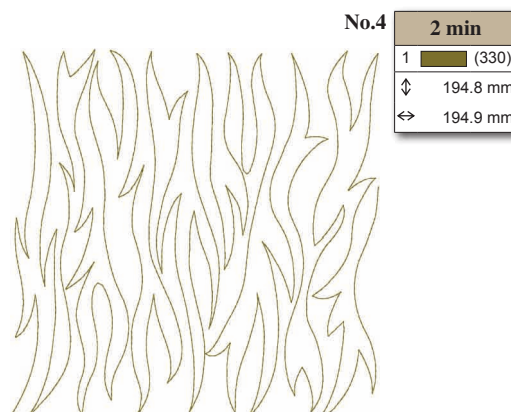
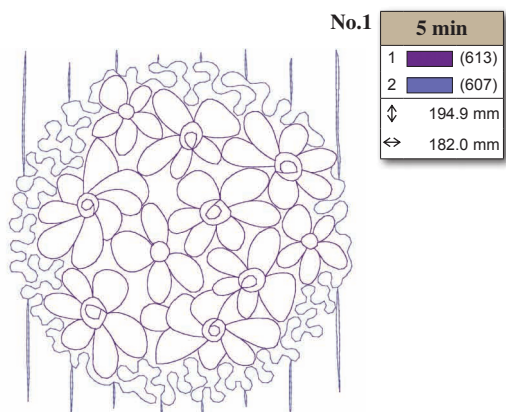

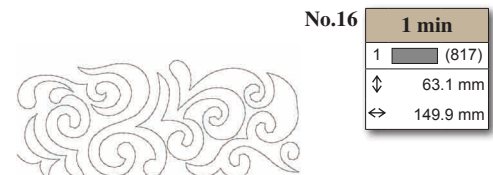
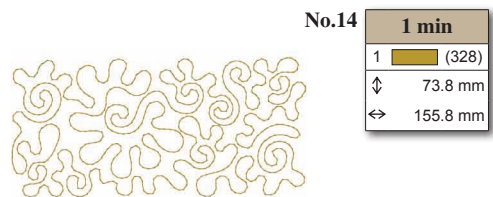
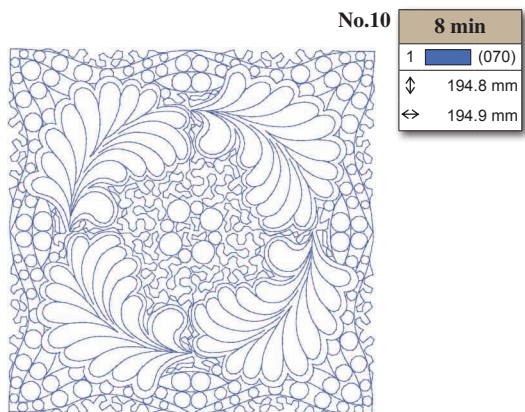
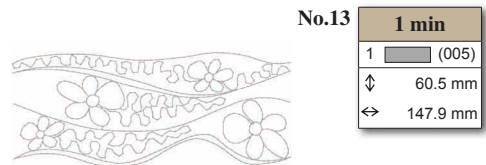
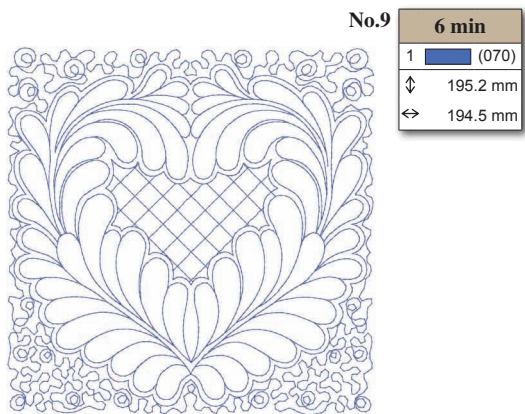
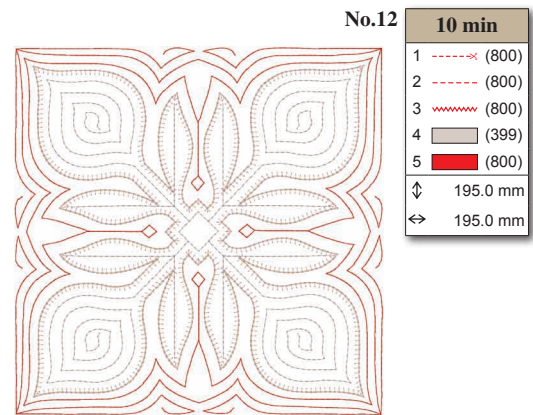
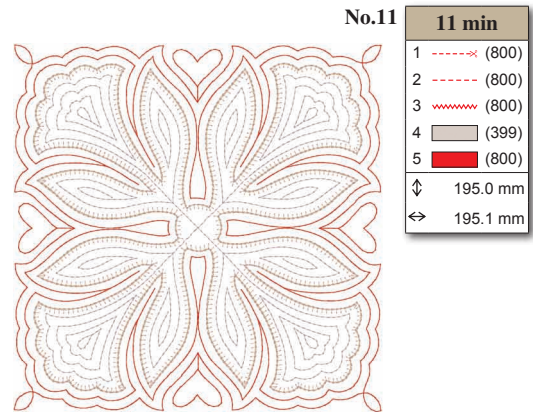
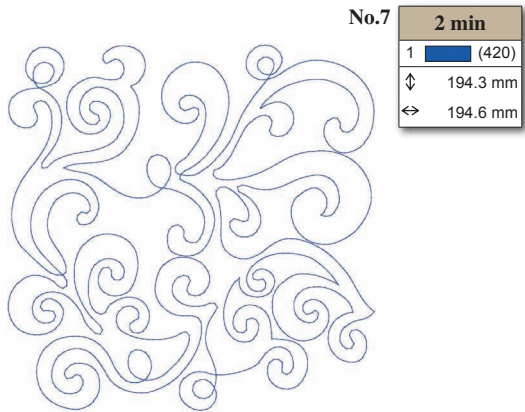

**Embroidery Patterns Color Change Table**  
**Tableau de changement de couleur des motifs de broderie**  
**Tabella dei cambi colore dei ricami**  
**Tabela de alteração de cor do padrão de bordado**

**Stickdesign-Farbtabelle**  
**Kleurenvolgorde voor de borduurontwerpen**  
**Tabla de cambios de color para diseños de bordado**  
**Таблицы цветов нитей для вышивок**

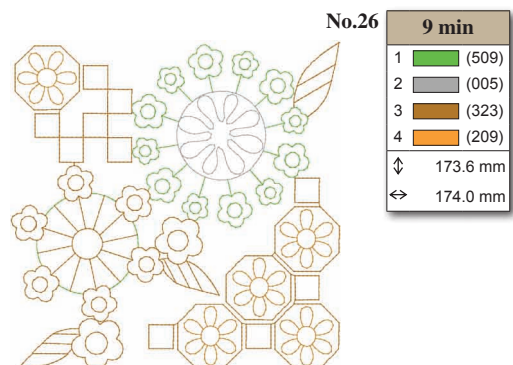
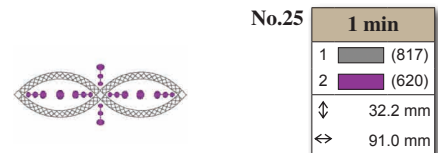
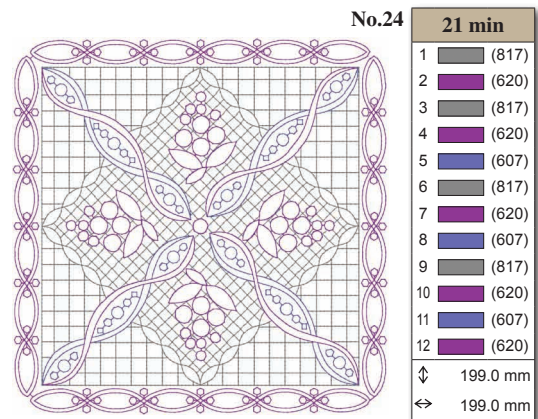
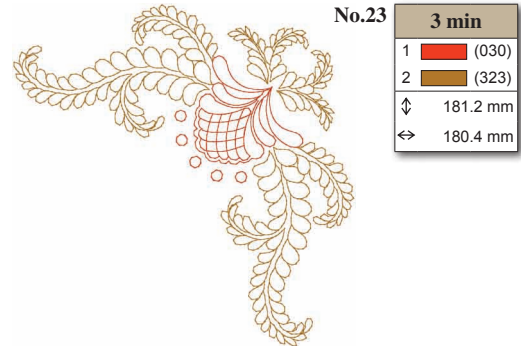
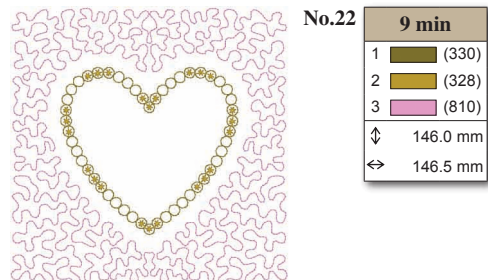
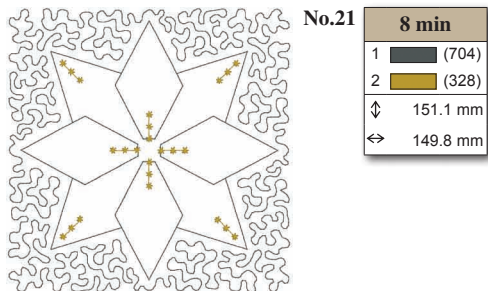
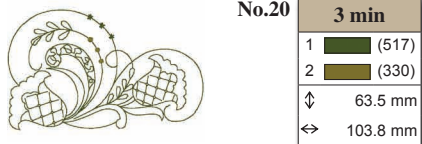
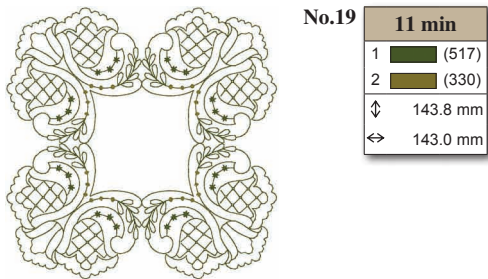
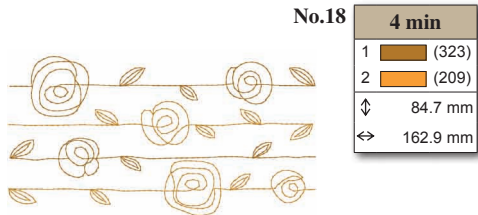
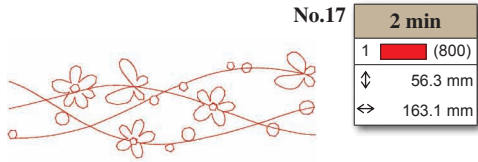

Refer to the operation manual for the embroidery machine for details on how to embroider appliqués.  
 Weitere Hinweise zum Sticken von Applikationen finden Sie in der Bedienungsanleitung der Stickmaschine.  
 Reportez-vous au manuel d'instructions de la machine à broder pour plus d'informations sur la broderie des appliqués.  
 Raadpleeg de bedieningshandleiding bij de borduurmachine voor gedetailleerde uitleg over het borduren van applicaties.  
 Consultare il manuale di istruzioni della macchina per ricamare per i dettagli relativi al ricamo in appliqué.  
 Consulte el manual de instrucciones de la máquina de bordar si desea más información sobre cómo bordar apliques.  
 Consulte o manual de operações da máquina de bordar para obter detalhes sobre como bordar apliques.  
 Инструкции по вышиванию аппликаций приведены в руководстве пользователя машины.



**No.27**

<b>2 min</b>	
1	■ (323)
2	■ (509)
↕	180.9 mm
↔	45.3 mm



**No.28**

<b>3 min</b>	
1	■ (517)
2	■ (208)
3	■ (800)
↕	123.9 mm
↔	59.4 mm



**No.29**

<b>3 min</b>	
1	■ (214)
2	■ (330)
↕	95.3 mm
↔	83.5 mm



**No.30**

<b>2 min</b>	
1	■ (330)
↕	44.2 mm
↔	162.8 mm



**No.31**

<b>10 min</b>	
1	■ (107)
2	■ (005)
3	■ (415)
4	■ (214)
↕	188.7 mm
↔	191.2 mm

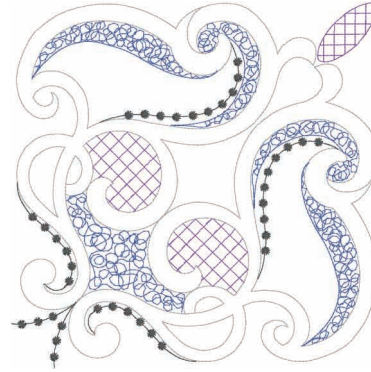

**No.32**

<b>11 min</b>	
1	■ (005)
2	■ (070)
3	■ (704)
4	■ (612)
↕	194.2 mm
↔	194.2 mm

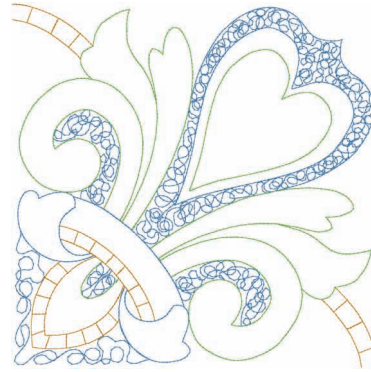

**No.33**

<b>12 min</b>	
1	■ (019)
2	■ (509)
3	■ (209)
4	■ (019)
5	■ (509)
↕	193.2 mm
↔	193.6 mm

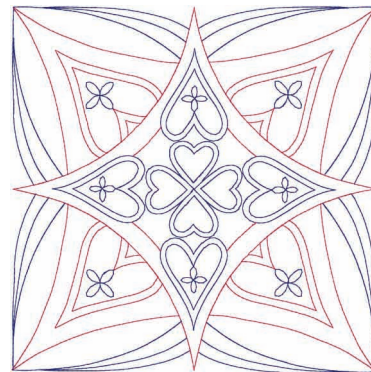

**No.34**

<b>7 min</b>	
1	■ (107)
2	■ (007)
3	■ (107)
↕	194.4 mm
↔	193.6 mm

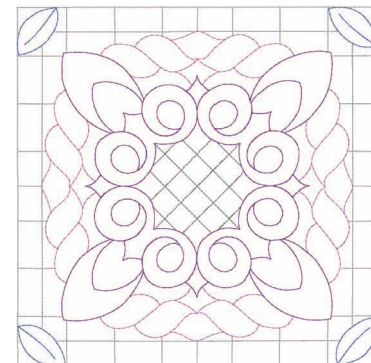

**No.35**

<b>13 min</b>	
1	■ (817)
2	■ (005)
3	■ (810)
4	■ (620)
5	■ (070)
↕	191.2 mm
↔	191.2 mm

Embroidery Patterns Color Change Table  
 Tableau de changement de couleur des motifs de broderie  
 Tabella dei cambi colore dei ricami  
 Tabela de alteração de cor do padrão de bordado

Stickdesign-Farbtabelle  
 Kleurenvolgeorde voor de borduurontwerpen  
 Tabla de cambios de color para diseños de bordado  
 Таблицы цветов нитей для вышивок

- ✂ Alphabet
- ✂ Alphabet
- ✂ Alfabeto
- ✂ Alfabeto
- ✂ Buchstaben
- ✂ Lettertypen
- ✂ Alfabeto
- ✂ Алфавиты

- Vintage
- Retro
- Vintage
- Vintage
- Vintage
- Classique
- Antiquo



**No.1** **17 min**

1 (323)

↓ 147.7 mm

↔ 129.6 mm

**No.6** **16 min**

1 (323)

↓ 149.3 mm

↔ 107.4 mm

**No.11** **20 min**

1 (323)

↓ 149.4 mm

↔ 125.1 mm

**No.2** **18 min**

1 (323)

↓ 149.9 mm

↔ 110.9 mm

**No.7** **17 min**

1 (323)

↓ 150.4 mm

↔ 111.7 mm

**No.12** **13 min**

1 (323)

↓ 149.2 mm

↔ 107.1 mm

**No.3** **13 min**

1 (323)

↓ 152.9 mm

↔ 102.3 mm

**No.8** **21 min**

1 (323)

↓ 149.1 mm

↔ 125.6 mm

**No.13** **28 min**

1 (323)

↓ 149.2 mm

↔ 150.1 mm

**No.4** **18 min**

1 (323)

↓ 149.3 mm

↔ 111.7 mm

**No.9** **10 min**

1 (323)

↓ 149.1 mm

↔ 58.0 mm

**No.14** **21 min**

1 (323)

↓ 149.7 mm

↔ 131.1 mm

**No.5** **19 min**

1 (323)

↓ 149.1 mm

↔ 109.7 mm

**No.10** **11 min**

1 (323)

↓ 148.8 mm

↔ 93.9 mm

**No.15** **19 min**

1 (323)

↓ 151.7 mm

↔ 107.1 mm

**No.16** **16 min**

1  (323)

↓ 149.4 mm

↔ 111.7 mm



**No.22** **14 min**

1  (323)

↓ 149.1 mm

↔ 110.2 mm



**No.27** **10 min**

1  (330)

↓ 195.5 mm

↔ 104.8 mm



**No.17** **18 min**

1  (323)

↓ 149.5 mm

↔ 108.2 mm



**No.23** **26 min**

1  (323)

↓ 149.2 mm

↔ 162.8 mm



**No.28** **11 min**

1  (330)

↓ 136.7 mm

↔ 123.8 mm



**No.18** **20 min**

1  (323)

↓ 149.3 mm

↔ 123.2 mm



**No.24** **17 min**

1  (323)

↓ 149.0 mm

↔ 115.2 mm



**No.29** **4 min**

1  (330)

↓ 85.9 mm

↔ 40.0 mm



**No.19** **17 min**

1  (323)

↓ 149.3 mm

↔ 91.2 mm



**No.25** **14 min**

1  (323)

↓ 149.2 mm

↔ 120.2 mm



**No.20** **16 min**

1  (323)

↓ 149.2 mm

↔ 118.8 mm

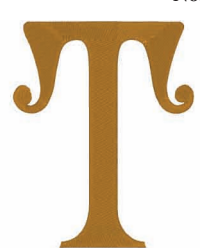

**No.26** **17 min**

1  (323)

↓ 147.9 mm

↔ 96.0 mm



**No.21** **16 min**

1  (323)

↓ 149.7 mm

↔ 117.4 mm

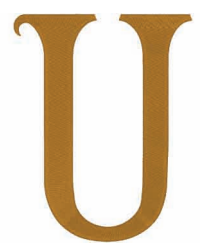









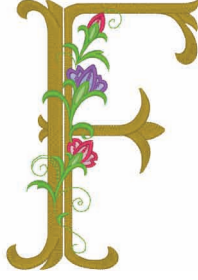

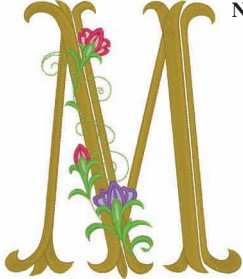

**Embroidery Patterns Color Change Table**  
**Tableau de changement de couleur des motifs de broderie**  
**Tabella dei cambi colore dei ricami**  
**Tabela de alteração de cor do padrão de bordado**

**Stickdesign-Farbtabelle**  
**Kleurenvolgorde voor de borduurontwerpen**  
**Tabla de cambios de color para diseños de bordado**  
**Таблицы цветов нитей для вышивок**

- Floral
- Bloemen
- Floral
- Blumen
- Floreale
- Цветочные



 <p><b>No.1</b></p> <table border="1" style="width: 100%; border-collapse: collapse;"> <tr><th colspan="2">17 min</th></tr> <tr><td style="text-align: center;">1</td><td style="text-align: center;">(328)</td></tr> <tr><td style="text-align: center;">2</td><td style="text-align: center;">(804)</td></tr> <tr><td style="text-align: center;">3</td><td style="text-align: center;">(612)</td></tr> <tr><td style="text-align: center;">4</td><td style="text-align: center;">(079)</td></tr> <tr><td style="text-align: center;">5</td><td style="text-align: center;">(807)</td></tr> <tr><td style="text-align: center;">6</td><td style="text-align: center;">(513)</td></tr> <tr><td style="text-align: center;">7</td><td style="text-align: center;">(502)</td></tr> <tr><td style="text-align: center;">↕</td><td style="text-align: center;">145.1 mm</td></tr> <tr><td style="text-align: center;">↔</td><td style="text-align: center;">125.7 mm</td></tr> </table>	17 min		1	(328)	2	(804)	3	(612)	4	(079)	5	(807)	6	(513)	7	(502)	↕	145.1 mm	↔	125.7 mm	 <p><b>No.6</b></p> <table border="1" style="width: 100%; border-collapse: collapse;"> <tr><th colspan="2">16 min</th></tr> <tr><td style="text-align: center;">1</td><td style="text-align: center;">(328)</td></tr> <tr><td style="text-align: center;">2</td><td style="text-align: center;">(804)</td></tr> <tr><td style="text-align: center;">3</td><td style="text-align: center;">(612)</td></tr> <tr><td style="text-align: center;">4</td><td style="text-align: center;">(079)</td></tr> <tr><td style="text-align: center;">5</td><td style="text-align: center;">(807)</td></tr> <tr><td style="text-align: center;">6</td><td style="text-align: center;">(513)</td></tr> <tr><td style="text-align: center;">7</td><td style="text-align: center;">(502)</td></tr> <tr><td style="text-align: center;">↕</td><td style="text-align: center;">142.8 mm</td></tr> <tr><td style="text-align: center;">↔</td><td style="text-align: center;">101.8 mm</td></tr> </table>	16 min		1	(328)	2	(804)	3	(612)	4	(079)	5	(807)	6	(513)	7	(502)	↕	142.8 mm	↔	101.8 mm	 <p><b>No.11</b></p> <table border="1" style="width: 100%; border-collapse: collapse;"> <tr><th colspan="2">20 min</th></tr> <tr><td style="text-align: center;">1</td><td style="text-align: center;">(328)</td></tr> <tr><td style="text-align: center;">2</td><td style="text-align: center;">(804)</td></tr> <tr><td style="text-align: center;">3</td><td style="text-align: center;">(612)</td></tr> <tr><td style="text-align: center;">4</td><td style="text-align: center;">(079)</td></tr> <tr><td style="text-align: center;">5</td><td style="text-align: center;">(807)</td></tr> <tr><td style="text-align: center;">6</td><td style="text-align: center;">(513)</td></tr> <tr><td style="text-align: center;">7</td><td style="text-align: center;">(502)</td></tr> <tr><td style="text-align: center;">↕</td><td style="text-align: center;">142.0 mm</td></tr> <tr><td style="text-align: center;">↔</td><td style="text-align: center;">119.6 mm</td></tr> </table>	20 min		1	(328)	2	(804)	3	(612)	4	(079)	5	(807)	6	(513)	7	(502)	↕	142.0 mm	↔	119.6 mm
17 min																																																														
1	(328)																																																													
2	(804)																																																													
3	(612)																																																													
4	(079)																																																													
5	(807)																																																													
6	(513)																																																													
7	(502)																																																													
↕	145.1 mm																																																													
↔	125.7 mm																																																													
16 min																																																														
1	(328)																																																													
2	(804)																																																													
3	(612)																																																													
4	(079)																																																													
5	(807)																																																													
6	(513)																																																													
7	(502)																																																													
↕	142.8 mm																																																													
↔	101.8 mm																																																													
20 min																																																														
1	(328)																																																													
2	(804)																																																													
3	(612)																																																													
4	(079)																																																													
5	(807)																																																													
6	(513)																																																													
7	(502)																																																													
↕	142.0 mm																																																													
↔	119.6 mm																																																													
 <p><b>No.2</b></p> <table border="1" style="width: 100%; border-collapse: collapse;"> <tr><th colspan="2">19 min</th></tr> <tr><td style="text-align: center;">1</td><td style="text-align: center;">(328)</td></tr> <tr><td style="text-align: center;">2</td><td style="text-align: center;">(804)</td></tr> <tr><td style="text-align: center;">3</td><td style="text-align: center;">(612)</td></tr> <tr><td style="text-align: center;">4</td><td style="text-align: center;">(079)</td></tr> <tr><td style="text-align: center;">5</td><td style="text-align: center;">(807)</td></tr> <tr><td style="text-align: center;">6</td><td style="text-align: center;">(513)</td></tr> <tr><td style="text-align: center;">7</td><td style="text-align: center;">(502)</td></tr> <tr><td style="text-align: center;">↕</td><td style="text-align: center;">140.9 mm</td></tr> <tr><td style="text-align: center;">↔</td><td style="text-align: center;">108.1 mm</td></tr> </table>	19 min		1	(328)	2	(804)	3	(612)	4	(079)	5	(807)	6	(513)	7	(502)	↕	140.9 mm	↔	108.1 mm	 <p><b>No.7</b></p> <table border="1" style="width: 100%; border-collapse: collapse;"> <tr><th colspan="2">19 min</th></tr> <tr><td style="text-align: center;">1</td><td style="text-align: center;">(328)</td></tr> <tr><td style="text-align: center;">2</td><td style="text-align: center;">(804)</td></tr> <tr><td style="text-align: center;">3</td><td style="text-align: center;">(612)</td></tr> <tr><td style="text-align: center;">4</td><td style="text-align: center;">(079)</td></tr> <tr><td style="text-align: center;">5</td><td style="text-align: center;">(807)</td></tr> <tr><td style="text-align: center;">6</td><td style="text-align: center;">(513)</td></tr> <tr><td style="text-align: center;">7</td><td style="text-align: center;">(502)</td></tr> <tr><td style="text-align: center;">↕</td><td style="text-align: center;">141.6 mm</td></tr> <tr><td style="text-align: center;">↔</td><td style="text-align: center;">117.3 mm</td></tr> </table>	19 min		1	(328)	2	(804)	3	(612)	4	(079)	5	(807)	6	(513)	7	(502)	↕	141.6 mm	↔	117.3 mm	 <p><b>No.12</b></p> <table border="1" style="width: 100%; border-collapse: collapse;"> <tr><th colspan="2">15 min</th></tr> <tr><td style="text-align: center;">1</td><td style="text-align: center;">(328)</td></tr> <tr><td style="text-align: center;">2</td><td style="text-align: center;">(804)</td></tr> <tr><td style="text-align: center;">3</td><td style="text-align: center;">(612)</td></tr> <tr><td style="text-align: center;">4</td><td style="text-align: center;">(079)</td></tr> <tr><td style="text-align: center;">5</td><td style="text-align: center;">(807)</td></tr> <tr><td style="text-align: center;">6</td><td style="text-align: center;">(513)</td></tr> <tr><td style="text-align: center;">7</td><td style="text-align: center;">(502)</td></tr> <tr><td style="text-align: center;">↕</td><td style="text-align: center;">144.9 mm</td></tr> <tr><td style="text-align: center;">↔</td><td style="text-align: center;">107.0 mm</td></tr> </table>	15 min		1	(328)	2	(804)	3	(612)	4	(079)	5	(807)	6	(513)	7	(502)	↕	144.9 mm	↔	107.0 mm
19 min																																																														
1	(328)																																																													
2	(804)																																																													
3	(612)																																																													
4	(079)																																																													
5	(807)																																																													
6	(513)																																																													
7	(502)																																																													
↕	140.9 mm																																																													
↔	108.1 mm																																																													
19 min																																																														
1	(328)																																																													
2	(804)																																																													
3	(612)																																																													
4	(079)																																																													
5	(807)																																																													
6	(513)																																																													
7	(502)																																																													
↕	141.6 mm																																																													
↔	117.3 mm																																																													
15 min																																																														
1	(328)																																																													
2	(804)																																																													
3	(612)																																																													
4	(079)																																																													
5	(807)																																																													
6	(513)																																																													
7	(502)																																																													
↕	144.9 mm																																																													
↔	107.0 mm																																																													
 <p><b>No.3</b></p> <table border="1" style="width: 100%; border-collapse: collapse;"> <tr><th colspan="2">16 min</th></tr> <tr><td style="text-align: center;">1</td><td style="text-align: center;">(328)</td></tr> <tr><td style="text-align: center;">2</td><td style="text-align: center;">(804)</td></tr> <tr><td style="text-align: center;">3</td><td style="text-align: center;">(612)</td></tr> <tr><td style="text-align: center;">4</td><td style="text-align: center;">(079)</td></tr> <tr><td style="text-align: center;">5</td><td style="text-align: center;">(807)</td></tr> <tr><td style="text-align: center;">6</td><td style="text-align: center;">(513)</td></tr> <tr><td style="text-align: center;">7</td><td style="text-align: center;">(502)</td></tr> <tr><td style="text-align: center;">↕</td><td style="text-align: center;">141.8 mm</td></tr> <tr><td style="text-align: center;">↔</td><td style="text-align: center;">114.5 mm</td></tr> </table>	16 min		1	(328)	2	(804)	3	(612)	4	(079)	5	(807)	6	(513)	7	(502)	↕	141.8 mm	↔	114.5 mm	 <p><b>No.8</b></p> <table border="1" style="width: 100%; border-collapse: collapse;"> <tr><th colspan="2">22 min</th></tr> <tr><td style="text-align: center;">1</td><td style="text-align: center;">(328)</td></tr> <tr><td style="text-align: center;">2</td><td style="text-align: center;">(804)</td></tr> <tr><td style="text-align: center;">3</td><td style="text-align: center;">(612)</td></tr> <tr><td style="text-align: center;">4</td><td style="text-align: center;">(079)</td></tr> <tr><td style="text-align: center;">5</td><td style="text-align: center;">(807)</td></tr> <tr><td style="text-align: center;">6</td><td style="text-align: center;">(513)</td></tr> <tr><td style="text-align: center;">7</td><td style="text-align: center;">(502)</td></tr> <tr><td style="text-align: center;">↕</td><td style="text-align: center;">141.7 mm</td></tr> <tr><td style="text-align: center;">↔</td><td style="text-align: center;">121.6 mm</td></tr> </table>	22 min		1	(328)	2	(804)	3	(612)	4	(079)	5	(807)	6	(513)	7	(502)	↕	141.7 mm	↔	121.6 mm	 <p><b>No.13</b></p> <table border="1" style="width: 100%; border-collapse: collapse;"> <tr><th colspan="2">23 min</th></tr> <tr><td style="text-align: center;">1</td><td style="text-align: center;">(328)</td></tr> <tr><td style="text-align: center;">2</td><td style="text-align: center;">(804)</td></tr> <tr><td style="text-align: center;">3</td><td style="text-align: center;">(612)</td></tr> <tr><td style="text-align: center;">4</td><td style="text-align: center;">(079)</td></tr> <tr><td style="text-align: center;">5</td><td style="text-align: center;">(807)</td></tr> <tr><td style="text-align: center;">6</td><td style="text-align: center;">(513)</td></tr> <tr><td style="text-align: center;">7</td><td style="text-align: center;">(502)</td></tr> <tr><td style="text-align: center;">↕</td><td style="text-align: center;">146.5 mm</td></tr> <tr><td style="text-align: center;">↔</td><td style="text-align: center;">124.6 mm</td></tr> </table>	23 min		1	(328)	2	(804)	3	(612)	4	(079)	5	(807)	6	(513)	7	(502)	↕	146.5 mm	↔	124.6 mm
16 min																																																														
1	(328)																																																													
2	(804)																																																													
3	(612)																																																													
4	(079)																																																													
5	(807)																																																													
6	(513)																																																													
7	(502)																																																													
↕	141.8 mm																																																													
↔	114.5 mm																																																													
22 min																																																														
1	(328)																																																													
2	(804)																																																													
3	(612)																																																													
4	(079)																																																													
5	(807)																																																													
6	(513)																																																													
7	(502)																																																													
↕	141.7 mm																																																													
↔	121.6 mm																																																													
23 min																																																														
1	(328)																																																													
2	(804)																																																													
3	(612)																																																													
4	(079)																																																													
5	(807)																																																													
6	(513)																																																													
7	(502)																																																													
↕	146.5 mm																																																													
↔	124.6 mm																																																													
 <p><b>No.4</b></p> <table border="1" style="width: 100%; border-collapse: collapse;"> <tr><th colspan="2">19 min</th></tr> <tr><td style="text-align: center;">1</td><td style="text-align: center;">(328)</td></tr> <tr><td style="text-align: center;">2</td><td style="text-align: center;">(804)</td></tr> <tr><td style="text-align: center;">3</td><td style="text-align: center;">(612)</td></tr> <tr><td style="text-align: center;">4</td><td style="text-align: center;">(079)</td></tr> <tr><td style="text-align: center;">5</td><td style="text-align: center;">(807)</td></tr> <tr><td style="text-align: center;">6</td><td style="text-align: center;">(513)</td></tr> <tr><td style="text-align: center;">7</td><td style="text-align: center;">(502)</td></tr> <tr><td style="text-align: center;">↕</td><td style="text-align: center;">141.2 mm</td></tr> <tr><td style="text-align: center;">↔</td><td style="text-align: center;">108.3 mm</td></tr> </table>	19 min		1	(328)	2	(804)	3	(612)	4	(079)	5	(807)	6	(513)	7	(502)	↕	141.2 mm	↔	108.3 mm	 <p><b>No.9</b></p> <table border="1" style="width: 100%; border-collapse: collapse;"> <tr><th colspan="2">14 min</th></tr> <tr><td style="text-align: center;">1</td><td style="text-align: center;">(328)</td></tr> <tr><td style="text-align: center;">2</td><td style="text-align: center;">(804)</td></tr> <tr><td style="text-align: center;">3</td><td style="text-align: center;">(612)</td></tr> <tr><td style="text-align: center;">4</td><td style="text-align: center;">(079)</td></tr> <tr><td style="text-align: center;">5</td><td style="text-align: center;">(807)</td></tr> <tr><td style="text-align: center;">6</td><td style="text-align: center;">(513)</td></tr> <tr><td style="text-align: center;">7</td><td style="text-align: center;">(502)</td></tr> <tr><td style="text-align: center;">↕</td><td style="text-align: center;">145.8 mm</td></tr> <tr><td style="text-align: center;">↔</td><td style="text-align: center;">49.7 mm</td></tr> </table>	14 min		1	(328)	2	(804)	3	(612)	4	(079)	5	(807)	6	(513)	7	(502)	↕	145.8 mm	↔	49.7 mm	 <p><b>No.14</b></p> <table border="1" style="width: 100%; border-collapse: collapse;"> <tr><th colspan="2">20 min</th></tr> <tr><td style="text-align: center;">1</td><td style="text-align: center;">(328)</td></tr> <tr><td style="text-align: center;">2</td><td style="text-align: center;">(804)</td></tr> <tr><td style="text-align: center;">3</td><td style="text-align: center;">(612)</td></tr> <tr><td style="text-align: center;">4</td><td style="text-align: center;">(079)</td></tr> <tr><td style="text-align: center;">5</td><td style="text-align: center;">(807)</td></tr> <tr><td style="text-align: center;">6</td><td style="text-align: center;">(513)</td></tr> <tr><td style="text-align: center;">7</td><td style="text-align: center;">(502)</td></tr> <tr><td style="text-align: center;">↕</td><td style="text-align: center;">147.0 mm</td></tr> <tr><td style="text-align: center;">↔</td><td style="text-align: center;">116.8 mm</td></tr> </table>	20 min		1	(328)	2	(804)	3	(612)	4	(079)	5	(807)	6	(513)	7	(502)	↕	147.0 mm	↔	116.8 mm
19 min																																																														
1	(328)																																																													
2	(804)																																																													
3	(612)																																																													
4	(079)																																																													
5	(807)																																																													
6	(513)																																																													
7	(502)																																																													
↕	141.2 mm																																																													
↔	108.3 mm																																																													
14 min																																																														
1	(328)																																																													
2	(804)																																																													
3	(612)																																																													
4	(079)																																																													
5	(807)																																																													
6	(513)																																																													
7	(502)																																																													
↕	145.8 mm																																																													
↔	49.7 mm																																																													
20 min																																																														
1	(328)																																																													
2	(804)																																																													
3	(612)																																																													
4	(079)																																																													
5	(807)																																																													
6	(513)																																																													
7	(502)																																																													
↕	147.0 mm																																																													
↔	116.8 mm																																																													
 <p><b>No.5</b></p> <table border="1" style="width: 100%; border-collapse: collapse;"> <tr><th colspan="2">18 min</th></tr> <tr><td style="text-align: center;">1</td><td style="text-align: center;">(328)</td></tr> <tr><td style="text-align: center;">2</td><td style="text-align: center;">(804)</td></tr> <tr><td style="text-align: center;">3</td><td style="text-align: center;">(612)</td></tr> <tr><td style="text-align: center;">4</td><td style="text-align: center;">(079)</td></tr> <tr><td style="text-align: center;">5</td><td style="text-align: center;">(807)</td></tr> <tr><td style="text-align: center;">6</td><td style="text-align: center;">(513)</td></tr> <tr><td style="text-align: center;">7</td><td style="text-align: center;">(502)</td></tr> <tr><td style="text-align: center;">↕</td><td style="text-align: center;">144.3 mm</td></tr> <tr><td style="text-align: center;">↔</td><td style="text-align: center;">102.5 mm</td></tr> </table>	18 min		1	(328)	2	(804)	3	(612)	4	(079)	5	(807)	6	(513)	7	(502)	↕	144.3 mm	↔	102.5 mm	 <p><b>No.10</b></p> <table border="1" style="width: 100%; border-collapse: collapse;"> <tr><th colspan="2">15 min</th></tr> <tr><td style="text-align: center;">1</td><td style="text-align: center;">(328)</td></tr> <tr><td style="text-align: center;">2</td><td style="text-align: center;">(804)</td></tr> <tr><td style="text-align: center;">3</td><td style="text-align: center;">(612)</td></tr> <tr><td style="text-align: center;">4</td><td style="text-align: center;">(079)</td></tr> <tr><td style="text-align: center;">5</td><td style="text-align: center;">(807)</td></tr> <tr><td style="text-align: center;">6</td><td style="text-align: center;">(513)</td></tr> <tr><td style="text-align: center;">7</td><td style="text-align: center;">(502)</td></tr> <tr><td style="text-align: center;">↕</td><td style="text-align: center;">144.5 mm</td></tr> <tr><td style="text-align: center;">↔</td><td style="text-align: center;">82.3 mm</td></tr> </table>	15 min		1	(328)	2	(804)	3	(612)	4	(079)	5	(807)	6	(513)	7	(502)	↕	144.5 mm	↔	82.3 mm	 <p><b>No.15</b></p> <table border="1" style="width: 100%; border-collapse: collapse;"> <tr><th colspan="2">18 min</th></tr> <tr><td style="text-align: center;">1</td><td style="text-align: center;">(328)</td></tr> <tr><td style="text-align: center;">2</td><td style="text-align: center;">(804)</td></tr> <tr><td style="text-align: center;">3</td><td style="text-align: center;">(612)</td></tr> <tr><td style="text-align: center;">4</td><td style="text-align: center;">(079)</td></tr> <tr><td style="text-align: center;">5</td><td style="text-align: center;">(807)</td></tr> <tr><td style="text-align: center;">6</td><td style="text-align: center;">(513)</td></tr> <tr><td style="text-align: center;">7</td><td style="text-align: center;">(502)</td></tr> <tr><td style="text-align: center;">↕</td><td style="text-align: center;">146.3 mm</td></tr> <tr><td style="text-align: center;">↔</td><td style="text-align: center;">115.3 mm</td></tr> </table>	18 min		1	(328)	2	(804)	3	(612)	4	(079)	5	(807)	6	(513)	7	(502)	↕	146.3 mm	↔	115.3 mm
18 min																																																														
1	(328)																																																													
2	(804)																																																													
3	(612)																																																													
4	(079)																																																													
5	(807)																																																													
6	(513)																																																													
7	(502)																																																													
↕	144.3 mm																																																													
↔	102.5 mm																																																													
15 min																																																														
1	(328)																																																													
2	(804)																																																													
3	(612)																																																													
4	(079)																																																													
5	(807)																																																													
6	(513)																																																													
7	(502)																																																													
↕	144.5 mm																																																													
↔	82.3 mm																																																													
18 min																																																														
1	(328)																																																													
2	(804)																																																													
3	(612)																																																													
4	(079)																																																													
5	(807)																																																													
6	(513)																																																													
7	(502)																																																													
↕	146.3 mm																																																													
↔	115.3 mm																																																													



No.16

17 min	
1	(328)
2	(804)
3	(612)
4	(079)
5	(807)
6	(513)
7	(502)
↓	143.4 mm
↔	99.6 mm



No.20

18 min	
1	(328)
2	(804)
3	(612)
4	(079)
5	(807)
6	(513)
7	(502)
↓	144.5 mm
↔	118.4 mm



No.24

18 min	
1	(328)
2	(804)
3	(612)
4	(079)
5	(807)
6	(513)
7	(502)
↓	142.3 mm
↔	115.9 mm



No.17

20 min	
1	(328)
2	(804)
3	(612)
4	(079)
5	(807)
6	(513)
7	(502)
↓	142.7 mm
↔	118.2 mm



No.21

17 min	
1	(328)
2	(804)
3	(612)
4	(079)
5	(807)
6	(513)
7	(502)
↓	144.6 mm
↔	118.5 mm



No.25

16 min	
1	(328)
2	(804)
3	(612)
4	(079)
5	(807)
6	(513)
7	(502)
↓	142.8 mm
↔	116.3 mm



No.18

21 min	
1	(328)
2	(804)
3	(612)
4	(079)
5	(807)
6	(513)
7	(502)
↓	143.4 mm
↔	112.5 mm



No.22

17 min	
1	(328)
2	(804)
3	(612)
4	(079)
5	(807)
6	(513)
7	(502)
↓	145.5 mm
↔	121.5 mm



No.26

19 min	
1	(328)
2	(804)
3	(612)
4	(079)
5	(807)
6	(513)
7	(502)
↓	142.8 mm
↔	92.9 mm



No.19

21 min	
1	(328)
2	(804)
3	(612)
4	(079)
5	(807)
6	(513)
7	(502)
↓	144.1 mm
↔	99.4 mm



No.23

23 min	
1	(328)
2	(804)
3	(612)
4	(079)
5	(807)
6	(513)
7	(502)
↓	146.2 mm
↔	124.8 mm

◆Example ◆Beispiel ◆Exemple ◆Voorbeeld  
◆Esempio ◆Ejemplo ◆Exemple ◆Пример

26 min	
1	(328)
2	(804)
3	(612)
4	(079)
5	(807)
6	(513)
7	(502)
↓	142.8 mm
↔	92.9 mm



No.27

3 min	
1	(328)
2	(079)
3	(807)
4	(513)
5	(502)
↓	51.9 mm
↔	45.9 mm



No.29

3 min	
1	(328)
2	(079)
3	(807)
4	(513)
5	(502)
↓	52.2 mm
↔	41.1 mm



No.31

3 min	
1	(328)
2	(079)
3	(807)
4	(513)
5	(502)
↓	53.1 mm
↔	37.3 mm



No.28

3 min	
1	(328)
2	(079)
3	(807)
4	(513)
5	(502)
↓	51.7 mm
↔	39.6 mm



No.30

3 min	
1	(328)
2	(079)
3	(807)
4	(513)
5	(502)
↓	51.9 mm
↔	39.3 mm



No.32

3 min	
1	(328)
2	(079)
3	(807)
4	(513)
5	(502)
↓	52.1 mm
↔	36.6 mm



**Embroidery Patterns Color Change Table**  
**Tableau de changement de couleur des motifs de broderie**  
**Tabella dei cambi colore dei ricami**  
**Tabela de alteração de cor do padrão de bordado**

**Stickdesign-Farbtabelle**  
**Kleurenvolgorde voor de borduurentwerpen**  
**Tabla de cambios de color para diseños de bordado**  
**Таблицы цветов нитей для вышивок**

**No.33**

3 min	
1	(328)
2	(079)
3	(807)
4	(513)
5	(502)
↓	51.9 mm
↔	42.7 mm

**No.38**

3 min	
1	(328)
2	(079)
3	(807)
4	(513)
5	(502)
↓	52.5 mm
↔	38.9 mm

**No.43**

3 min	
1	(328)
2	(079)
3	(807)
4	(513)
5	(502)
↓	52.6 mm
↔	43.3 mm

**No.48**

3 min	
1	(328)
2	(079)
3	(807)
4	(513)
5	(502)
↓	52.8 mm
↔	43.9 mm

**No.34**

4 min	
1	(328)
2	(079)
3	(807)
4	(513)
5	(502)
↓	52.2 mm
↔	44.3 mm

**No.39**

4 min	
1	(328)
2	(079)
3	(807)
4	(513)
5	(502)
↓	53.3 mm
↔	46.4 mm

**No.44**

4 min	
1	(328)
2	(079)
3	(807)
4	(513)
5	(502)
↓	52.3 mm
↔	40.7 mm

**No.49**

4 min	
1	(328)
2	(079)
3	(807)
4	(513)
5	(502)
↓	53.3 mm
↔	46.5 mm

**No.35**

3 min	
1	(328)
2	(079)
3	(807)
4	(513)
5	(502)
↓	53.9 mm
↔	23.8 mm

**No.40**

4 min	
1	(328)
2	(079)
3	(807)
4	(513)
5	(502)
↓	52.9 mm
↔	43.1 mm

**No.45**

3 min	
1	(328)
2	(079)
3	(807)
4	(513)
5	(502)
↓	52.6 mm
↔	35.0 mm

**No.50**

3 min	
1	(328)
2	(079)
3	(807)
4	(513)
5	(502)
↓	51.7 mm
↔	42.0 mm

**No.36**

3 min	
1	(328)
2	(079)
3	(807)
4	(513)
5	(502)
↓	52.6 mm
↔	30.1 mm

**No.41**

3 min	
1	(328)
2	(079)
3	(807)
4	(513)
5	(502)
↓	52.8 mm
↔	42.6 mm

**No.46**

3 min	
1	(328)
2	(079)
3	(807)
4	(513)
5	(502)
↓	53.0 mm
↔	42.0 mm

**No.51**

3 min	
1	(328)
2	(079)
3	(807)
4	(513)
5	(502)
↓	53.8 mm
↔	42.2 mm

**No.37**

4 min	
1	(328)
2	(079)
3	(807)
4	(513)
5	(502)
↓	52.4 mm
↔	43.4 mm

**No.42**

3 min	
1	(328)
2	(079)
3	(807)
4	(513)
5	(502)
↓	52.1 mm
↔	36.9 mm

**No.47**

3 min	
1	(328)
2	(079)
3	(807)
4	(513)
5	(502)
↓	52.5 mm
↔	42.8 mm

**No.52**

3 min	
1	(328)
2	(079)
3	(807)
4	(513)
5	(502)
↓	52.4 mm
↔	33.4 mm

**No.53**

2 min	
1	(804)
2	(612)
3	(079)
4	(807)
5	(513)
6	(502)
↓	34.4 mm
↔	22.7 mm

**No.55**

3 min					
1	(804)	3	(079)	5	(513)
2	(612)	4	(807)	6	(502)
↓ 39.3 mm ↔ 75.4 mm					

**No.57**

6 min														
1	(804)	7	(804)	13	(079)									
2	(612)	8	(612)	14	(807)									
3	(079)	9	(079)	15	(513)									
4	(807)	10	(807)	16	(502)									
5	(513)	11	(513)											
6	(502)	12	(502)											
↓ 27.9 mm ↔ 121.9 mm														

**No.54**

2 min	
1	(079)
2	(807)
3	(513)
4	(502)
↓	39.8 mm
↔	25.6 mm

**No.56**

5 min											
1	(804)	5	(513)	9	(079)						
2	(612)	6	(502)	10	(807)						
3	(079)	7	(804)	11	(513)						
4	(807)	8	(612)	12	(502)						
↓ 23.4 mm ↔ 123.7 mm											



No. 58

11 min		
1 (079)	7 (513)	13 (079)
2 (807)	8 (502)	14 (807)
3 (513)	9 (079)	15 (513)
4 (502)	10 (807)	16 (502)
5 (079)	11 (513)	
6 (807)	12 (502)	
⇅ 103.6 mm ⇔ 94.9 mm		



No.60

4 min	
1 (513)	
2 (807)	
3 (513)	
4 (807)	
⇅ 106.7 mm	
⇔ 93.4 mm	



No.63

1 min	
1 (513)	
⇅ 147.2 mm	
⇔ 61.8 mm	



No.59

20 min		
1 (079)	17 (513)	33 (804)
2 (807)	18 (502)	34 (612)
3 (804)	19 (079)	35 (513)
4 (612)	20 (807)	36 (502)
5 (513)	21 (804)	37 (079)
6 (502)	22 (612)	38 (807)
7 (079)	23 (513)	39 (804)
8 (807)	24 (502)	40 (612)
9 (804)	25 (079)	41 (513)
10 (612)	26 (807)	42 (502)
11 (513)	27 (804)	43 (079)
12 (502)	28 (612)	44 (807)
13 (079)	29 (513)	45 (804)
14 (807)	30 (502)	46 (612)
15 (804)	31 (079)	47 (513)
16 (612)	32 (807)	48 (502)
⇅ 195.4 mm ⇔ 157.3 mm		



No.61

3 min	
1 (513)	
2 (807)	
3 (513)	
4 (807)	
⇅ 42.6 mm	
⇔ 142.0 mm	



No.62

11 min		
1 (513)	4 (807)	7 (513)
2 (807)	5 (513)	8 (807)
3 (513)	6 (807)	
⇅ 195.4 mm ⇔ 158.5 mm		



No.64

7 min		
1 (804)	9 (079)	17 (513)
2 (612)	10 (807)	18 (502)
3 (079)	11 (513)	19 (804)
4 (807)	12 (502)	20 (612)
5 (513)	13 (804)	21 (079)
6 (502)	14 (612)	22 (807)
7 (804)	15 (079)	23 (513)
8 (612)	16 (807)	24 (502)
⇅ 73.3 mm ⇔ 72.8 mm		

Embroidery Patterns Color Change Table  
 Tableau de changement de couleur des motifs de broderie  
 Tabella dei cambi colore dei ricami  
 Tabela de alteração de cor do padrão de bordado

Stickdesign-Farbtabelle  
 Kleurenvogorde voor de borduurontwerpen  
 Tabla de cambios de color para diseños de bordado  
 Таблицы цветов нитей для вышивок

- Line
- Sierlijk
- Lineare

- Linie
- Fune
- Линейные

- Ligne
- Línea



**No.1**

<b>L: 12 min</b>	
<b>S: 8 min</b>	
1	■ (005)
2	■ (807)
L:	↕ 125.1 mm
	↔ 103.3 mm
S:	↕ 95.9 mm
	↔ 79.1 mm



**No.4**

<b>L: 14 min</b>	
<b>S: 10 min</b>	
1	■ (005)
2	■ (807)
L:	↕ 124.8 mm
	↔ 95.8 mm
S:	↕ 95.8 mm
	↔ 73.8 mm



**No.7**

<b>L: 11 min</b>	
<b>S: 8 min</b>	
1	■ (005)
2	■ (807)
L:	↕ 125.0 mm
	↔ 87.6 mm
S:	↕ 95.8 mm
	↔ 67.2 mm



**No.2**

<b>L: 12 min</b>	
<b>S: 8 min</b>	
1	■ (005)
2	■ (807)
L:	↕ 124.8 mm
	↔ 86.6 mm
S:	↕ 95.7 mm
	↔ 66.4 mm



**No.5**

<b>L: 14 min</b>	
<b>S: 9 min</b>	
1	■ (005)
2	■ (807)
L:	↕ 124.8 mm
	↔ 87.8 mm
S:	↕ 95.8 mm
	↔ 67.4 mm

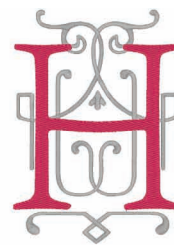

**No.8**

<b>L: 15 min</b>	
<b>S: 10 min</b>	
1	■ (005)
2	■ (807)
L:	↕ 125.0 mm
	↔ 89.8 mm
S:	↕ 95.7 mm
	↔ 68.8 mm

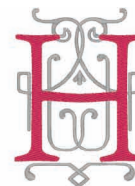

**No.3**

<b>L: 11 min</b>	
<b>S: 8 min</b>	
1	■ (005)
2	■ (807)
L:	↕ 124.8 mm
	↔ 85.6 mm
S:	↕ 95.8 mm
	↔ 65.8 mm



**No.6**

<b>L: 13 min</b>	
<b>S: 9 min</b>	
1	■ (005)
2	■ (807)
L:	↕ 124.8 mm
	↔ 80.8 mm
S:	↕ 95.8 mm
	↔ 61.8 mm



**No.9**

<b>L: 7 min</b>	
<b>S: 5 min</b>	
1	■ (005)
2	■ (807)
L:	↕ 124.9 mm
	↔ 66.0 mm
S:	↕ 95.8 mm
	↔ 50.6 mm





No.10

<b>L: 9 min</b>	
<b>S: 6 min</b>	
1	(005)
2	(807)
L:	↓ 124.9 mm
	↔ 75.4 mm
S:	↓ 95.8 mm
	↔ 57.8 mm



No.13

<b>L: 18 min</b>	
<b>S: 13 min</b>	
1	(005)
2	(807)
L:	↓ 125.0 mm
	↔ 117.6 mm
S:	↓ 95.8 mm
	↔ 90.4 mm



No.16

<b>L: 12 min</b>	
<b>S: 9 min</b>	
1	(005)
2	(807)
L:	↓ 125.0 mm
	↔ 82.6 mm
S:	↓ 95.8 mm
	↔ 63.2 mm



No.11

<b>L: 13 min</b>	
<b>S: 9 min</b>	
1	(005)
2	(807)
L:	↓ 125.0 mm
	↔ 95.6 mm
S:	↓ 95.8 mm
	↔ 73.4 mm



No.14

<b>L: 14 min</b>	
<b>S: 10 min</b>	
1	(005)
2	(807)
L:	↓ 124.8 mm
	↔ 96.0 mm
S:	↓ 95.8 mm
	↔ 73.6 mm

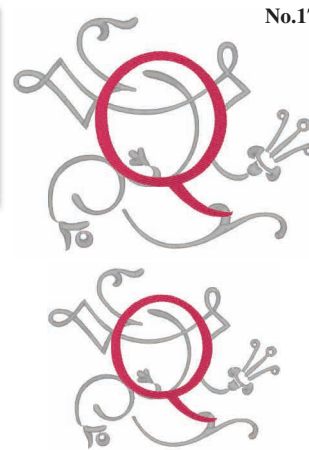

No.17

<b>L: 15 min</b>	
<b>S: 10 min</b>	
1	(005)
2	(807)
L:	↓ 124.8 mm
	↔ 160.4 mm
S:	↓ 96.0 mm
	↔ 123.2 mm



No.12

<b>L: 12 min</b>	
<b>S: 9 min</b>	
1	(005)
2	(807)
L:	↓ 124.9 mm
	↔ 88.1 mm
S:	↓ 95.8 mm
	↔ 67.6 mm

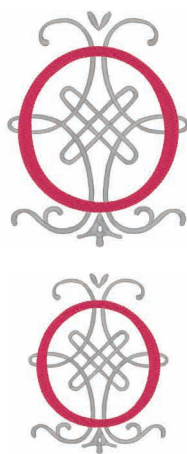

No.15

<b>L: 13 min</b>	
<b>S: 9 min</b>	
1	(005)
2	(807)
L:	↓ 124.6 mm
	↔ 96.8 mm
S:	↓ 95.8 mm
	↔ 74.4 mm



No.18

<b>L: 10 min</b>	
<b>S: 7 min</b>	
1	(005)
2	(807)
L:	↓ 124.8 mm
	↔ 79.6 mm
S:	↓ 95.8 mm
	↔ 61.2 mm



Embroidery Patterns Color Change Table  
 Tableau de changement de couleur des motifs de broderie  
 Tabella dei cambi colore dei ricami  
 Tabela de alteração de cor do padrão de bordado

Stickdesign-Farbtabelle  
 Kleurenvorgorde voor de borduurontwerpen  
 Tabla de cambios de color para diseños de bordado  
 Таблицы цветов нитей для вышивок



No.19

<b>L: 11 min</b>	
<b>S: 8 min</b>	
1	█ (005)
2	█ (807)
L:	↕ 125.0 mm
	↔ 77.2 mm
S:	↕ 95.8 mm
	↔ 59.2 mm



No.22

<b>L: 13 min</b>	
<b>S: 9 min</b>	
1	█ (005)
2	█ (807)
L:	↕ 124.5 mm
	↔ 103.8 mm
S:	↕ 95.8 mm
	↔ 80.0 mm



No.25

<b>L: 12 min</b>	
<b>S: 8 min</b>	
1	█ (005)
2	█ (807)
L:	↕ 124.8 mm
	↔ 95.6 mm
S:	↕ 95.8 mm
	↔ 73.4 mm



No.20

<b>L: 10 min</b>	
<b>S: 7 min</b>	
1	█ (005)
2	█ (807)
L:	↕ 124.8 mm
	↔ 82.8 mm
S:	↕ 95.8 mm
	↔ 63.6 mm



No.23

<b>L: 15 min</b>	
<b>S: 10 min</b>	
1	█ (005)
2	█ (807)
L:	↕ 124.8 mm
	↔ 124.8 mm
S:	↕ 95.8 mm
	↔ 96.0 mm



No.26

<b>L: 13 min</b>	
<b>S: 9 min</b>	
1	█ (005)
2	█ (807)
L:	↕ 124.4 mm
	↔ 106.3 mm
S:	↕ 95.8 mm
	↔ 81.8 mm



No.21

<b>L: 14 min</b>	
<b>S: 10 min</b>	
1	█ (005)
2	█ (807)
L:	↕ 124.8 mm
	↔ 125.8 mm
S:	↕ 95.8 mm
	↔ 96.6 mm

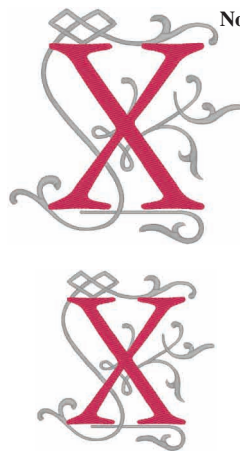

No.24

<b>L: 15 min</b>	
<b>S: 10 min</b>	
1	█ (005)
2	█ (807)
L:	↕ 124.8 mm
	↔ 123.8 mm
S:	↕ 95.8 mm
	↔ 94.8 mm

Patterns No.1 - No.30, are designed by Hang to Dry.  
 Designs Nr.1 - Nr.30 wurden von Hang to Dry entworfen.  
 Les motifs n° 1 à 30 sont conçus par Hang to Dry.  
 De ontwerpen 1-30 zijn ontworpen door Hang to Dry.  
 I ricami dal N° 1 al N° 30 sono stati ideati da Hang to Dry.  
 Los diseños del N°1 al N° 30 están diseñados por Hang to Dry.  
 Desenhos N° 1 a N° 30 criados por Hang to Dry.  
 Рисунки с № 1 по № 30 созданы дизайнерами компании Hang to Dry.

- Vine
- Wijnrank
- Videira

- Reben
- Vite
- Завивающиеся

- Vigne
- Vid



**No.1** **4 min**

1	(620)
2	(612)
↓	54.3 mm
↔	82.8 mm

**No.9** **2 min**

1	(620)
2	(612)
↓	55.0 mm
↔	68.3 mm

**No.17** **3 min**

1	(620)
2	(612)
↓	54.9 mm
↔	83.5 mm

**No.25** **3 min**

1	(620)
2	(612)
↓	53.1 mm
↔	65.9 mm

**No.2** **3 min**

1	(620)
2	(612)
↓	54.4 mm
↔	72.6 mm

**No.10** **3 min**

1	(620)
2	(612)
↓	54.3 mm
↔	71.0 mm

**No.18** **4 min**

1	(620)
2	(612)
↓	54.7 mm
↔	81.5 mm

**No.26** **3 min**

1	(620)
2	(612)
↓	55.9 mm
↔	70.0 mm

**No.3** **3 min**

1	(620)
2	(612)
↓	53.9 mm
↔	73.3 mm

**No.11** **3 min**

1	(620)
2	(612)
↓	55.2 mm
↔	85.3 mm

**No.19** **3 min**

1	(620)
2	(612)
↓	54.5 mm
↔	73.8 mm

**No.27** **3 min**

1	(620)
2	(612)
↓	57.4 mm
↔	57.7 mm

**No.4** **4 min**

1	(620)
2	(612)
↓	54.6 mm
↔	80.0 mm

**No.12** **3 min**

1	(620)
2	(612)
↓	53.9 mm
↔	75.0 mm

**No.20** **3 min**

1	(620)
2	(612)
↓	54.2 mm
↔	73.2 mm

**No.28**

<b>3 min</b>	
1	(620)
2	(612)
↓	31.5 mm ↔ 119.2 mm

**No.5** **3 min**

1	(620)
2	(612)
↓	55.0 mm
↔	65.3 mm

**No.13** **4 min**

1	(620)
2	(612)
↓	54.1 mm
↔	85.0 mm

**No.21** **3 min**

1	(620)
2	(612)
↓	53.6 mm
↔	78.3 mm

**No.29**

<b>2 min</b>	
1	(620)
2	(612)
↓	13.4 mm ↔ 195.4 mm

**No.6** **3 min**

1	(620)
2	(612)
↓	54.0 mm
↔	78.8 mm

**No.14** **3 min**

1	(620)
2	(612)
↓	54.6 mm
↔	84.8 mm

**No.22** **3 min**

1	(620)
2	(612)
↓	53.2 mm
↔	70.9 mm

**No.7** **3 min**

1	(620)
2	(612)
↓	54.6 mm
↔	70.4 mm

**No.15** **3 min**

1	(620)
2	(612)
↓	53.9 mm
↔	78.7 mm

**No.23** **4 min**

1	(620)
2	(612)
↓	53.4 mm
↔	82.6 mm

**No.1** **4 min**

1	(620)
2	(612)
↓	54.3 mm
↔	82.8 mm

**No.8** **4 min**

1	(620)
2	(612)
↓	54.3 mm
↔	83.3 mm

**No.16** **3 min**

1	(620)
2	(612)
↓	54.7 mm
↔	67.2 mm

**No.24** **3 min**

1	(620)
2	(612)
↓	53.2 mm
↔	83.4 mm

**Embroidery Patterns Color Change Table**  
**Tableau de changement de couleur des motifs de broderie**  
**Tabella dei cambi colore dei ricami**  
**Tabela de alteração de cor do padrão de bordado**

**Stickdesign-Farbtabelle**  
**Kleurenvolgorde voor de borduurontwerpen**  
**Tabla de cambios de color para diseños de bordado**  
**Таблицы цветов нитей для вышивок**

- Appliqué alphabet
- Applicatie lettertype
- Alfabeto para apliques

- Buchstabenapplikationen
- Alabeto in appliqué
- Алфавит для аппликации

- Alphabet d'appliqués
- Diseños alfabéticos con adornos

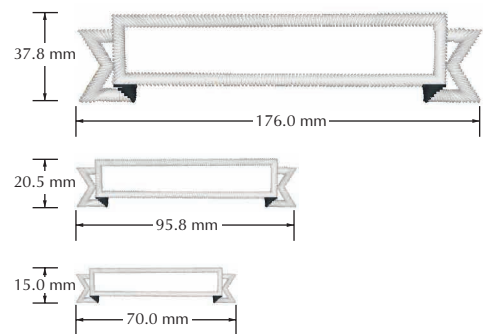
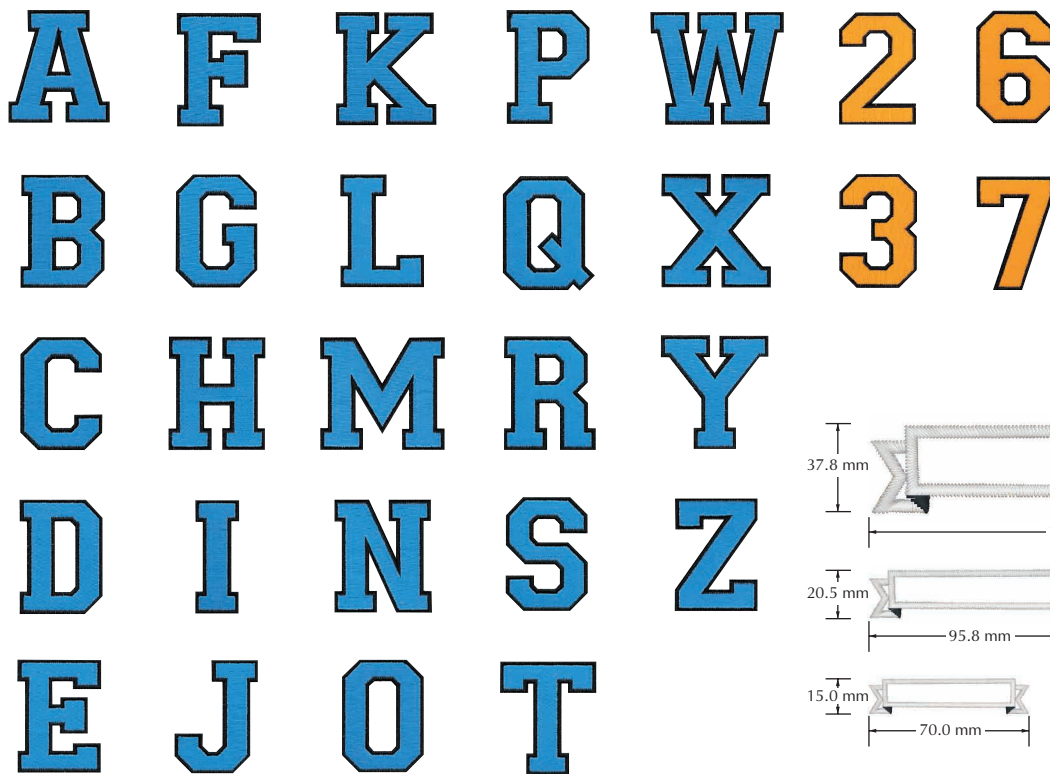
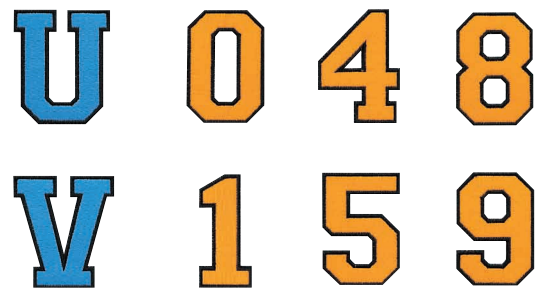

Refer to the operation manual for the embroidery machine for details on how to embroider appliqués.  
 Weitere Hinweise zum Sticken von Applikationen finden Sie in der Bedienungsanleitung der Stickmaschine.  
 Reportez-vous au manuel d'instructions de la machine à broder pour plus d'informations sur la broderie des appliqués.  
 Raadpleeg de bedieningshandleiding bij de borduurmachine voor gedetailleerde uitleg over het borduren van applicaties.  
 Consultare il manuale di istruzioni della macchina per ricamare per i dettagli relativi al ricamo in appliqué.  
 Consulte el manual de instrucciones de la máquina de bordar si desea más información sobre cómo bordar apliques.  
 Consulte o manual de operações da máquina de bordar para obter detalhes sobre como bordar apliques.  
 Инструкции по вышиванию аппликаций приведены в руководстве пользователя машины.

**Embroidery Patterns Color Change Table**  
**Tableau de changement de couleur des motifs de broderie**  
**Tabella dei cambi colore dei ricami**  
**Tabela de alteração de cor do padrão de bordado**

**Stickdesign-Farbtabelle**  
**Kleurenvolgorde voor de borduurontwerpen**  
**Tabla de cambios de color para diseños de bordado**  
**Таблицы цветов нитей для вышивок**

- Appliqué Greek alphabet
- Grieks applicatie lettertype
- Alfabeto greco para apliques

- Griechische Buchstaben für Applikationen
- Alfabeto greco in appliqué
- Греческий алфавит для аппликации

- Alphabet grec d'appliqués
- Alfabeto griego con adornos



<p><b>No.1</b> 3 min</p> <p>1 ..... (420)                  2 ..... (420)                  3 ..... (509)                  4 ..... (509)</p> <p>↓ 77.8 mm                  ⇔ 80.4 mm</p>	<p><b>No.7</b> 4 min</p> <p>1 ..... (420)                  2 ..... (420)                  3 ..... (509)                  4 ..... (509)</p> <p>↓ 75.9 mm                  ⇔ 78.5 mm</p>	<p><b>No.13</b> 4 min</p> <p>1 ..... (420)                  2 ..... (420)                  3 ..... (509)                  4 ..... (509)</p> <p>↓ 78.3 mm                  ⇔ 78.4 mm</p>	<p><b>No.19</b> 3 min</p> <p>1 ..... (420)                  2 ..... (420)                  3 ..... (509)                  4 ..... (509)</p> <p>↓ 76.1 mm                  ⇔ 68.0 mm</p>
<p><b>No.2</b> 4 min</p> <p>1 ..... (420)                  2 ..... (420)                  3 ..... (509)                  4 ..... (509)</p> <p>↓ 76.0 mm                  ⇔ 70.7 mm</p>	<p><b>No.8</b> 5 min</p> <p>1 ..... (420)                  2 ..... (420)                  3 ..... (509)                  4 ..... (509)</p> <p>↓ 80.2 mm                  ⇔ 73.9 mm</p>	<p><b>No.14</b> 5 min</p> <p>1 ..... (420)                  2 ..... (420)                  3 ..... (509)                  4 ..... (509)</p> <p>↓ 76.1 mm                  ⇔ 68.5 mm</p>	<p><b>No.20</b> 3 min</p> <p>1 ..... (420)                  2 ..... (420)                  3 ..... (509)                  4 ..... (509)</p> <p>↓ 75.9 mm                  ⇔ 79.1 mm</p>
<p><b>No.3</b> 3 min</p> <p>1 ..... (420)                  2 ..... (420)                  3 ..... (509)                  4 ..... (509)</p> <p>↓ 76.0 mm                  ⇔ 68.2 mm</p>	<p><b>No.9</b> 2 min</p> <p>1 ..... (420)                  2 ..... (420)                  3 ..... (509)                  4 ..... (509)</p> <p>↓ 76.0 mm                  ⇔ 38.1 mm</p>	<p><b>No.15</b> 3 min</p> <p>1 ..... (420)                  2 ..... (420)                  3 ..... (509)                  4 ..... (509)</p> <p>↓ 80.3 mm                  ⇔ 73.9 mm</p>	<p><b>No.21</b> 4 min</p> <p>1 ..... (420)                  2 ..... (420)                  3 ..... (509)                  4 ..... (509)</p> <p>↓ 75.9 mm                  ⇔ 78.0 mm</p>
<p><b>No.4</b> 3 min</p> <p>1 ..... (420)                  2 ..... (420)                  3 ..... (509)                  4 ..... (509)</p> <p>↓ 77.7 mm                  ⇔ 70.0 mm</p>	<p><b>No.10</b> 4 min</p> <p>1 ..... (420)                  2 ..... (420)                  3 ..... (509)                  4 ..... (509)</p> <p>↓ 76.1 mm                  ⇔ 80.5 mm</p>	<p><b>No.16</b> 4 min</p> <p>1 ..... (420)                  2 ..... (420)                  3 ..... (509)                  4 ..... (509)</p> <p>↓ 75.9 mm                  ⇔ 82.6 mm</p>	<p><b>No.22</b> 4 min</p> <p>1 ..... (420)                  2 ..... (420)                  3 ..... (509)                  4 ..... (509)</p> <p>↓ 76.0 mm                  ⇔ 80.8 mm</p>
<p><b>No.5</b> 4 min</p> <p>1 ..... (420)                  2 ..... (420)                  3 ..... (509)                  4 ..... (509)</p> <p>↓ 76.1 mm                  ⇔ 69.8 mm</p>	<p><b>No.11</b> 3 min</p> <p>1 ..... (420)                  2 ..... (420)                  3 ..... (509)                  4 ..... (509)</p> <p>↓ 78.0 mm                  ⇔ 76.0 mm</p>	<p><b>No.17</b> 3 min</p> <p>1 ..... (420)                  2 ..... (420)                  3 ..... (509)                  4 ..... (509)</p> <p>↓ 76.0 mm                  ⇔ 62.0 mm</p>	<p><b>No.23</b> 4 min</p> <p>1 ..... (420)                  2 ..... (420)                  3 ..... (509)                  4 ..... (509)</p> <p>↓ 76.0 mm                  ⇔ 86.7 mm</p>
<p><b>No.6</b> 3 min</p> <p>1 ..... (420)                  2 ..... (420)                  3 ..... (509)                  4 ..... (509)</p> <p>↓ 76.0 mm                  ⇔ 67.4 mm</p>	<p><b>No.12</b> 5 min</p> <p>1 ..... (420)                  2 ..... (420)                  3 ..... (509)                  4 ..... (509)</p> <p>↓ 76.0 mm                  ⇔ 95.3 mm</p>	<p><b>No.18</b> 4 min</p> <p>1 ..... (420)                  2 ..... (420)                  3 ..... (509)                  4 ..... (509)</p> <p>↓ 76.0 mm                  ⇔ 69.0 mm</p>	<p><b>No.24</b> 4 min</p> <p>1 ..... (420)                  2 ..... (420)                  3 ..... (509)                  4 ..... (509)</p> <p>↓ 78.0 mm                  ⇔ 74.1 mm</p>

Refer to the operation manual for the embroidery machine for details on how to embroider appliqués.  
 Weitere Hinweise zum Sticken von Applikationen finden Sie in der Bedienungsanleitung der Stickmaschine.  
 Reportez-vous au manuel d'instructions de la machine à broder pour plus d'informations sur la broderie des appliqués.  
 Raadpleeg de bedieningshandleiding bij de borduurmachine voor gedetailleerde uitleg over het borduren van applicaties.  
 Consultare il manuale di istruzioni della macchina per ricamare per i dettagli relativi al ricamo in appliqué.  
 Consulte el manual de instrucciones de la máquina de bordar si desea más información sobre cómo bordar apliques.  
 Consulte o manual de operações da máquina de bordar para obter detalhes sobre como bordar apliques.  
 Инструкции по вышиванию аппликаций приведены в руководстве пользователя машины.



**Examples of Combinations**  
**Exemples de combinaisons**  
**Esempi di combinazioni**  
**Exemplos de combinações**

**Kombinationsbeispiele**  
**Voorbeelden van combinaties**  
**Ejemplos de combinaciones**  
**Примеры комбинирования**

Combine various embroidery patterns, as shown below, to enhance your embroidering enjoyment.  
 Für noch mehr Freude am Sticken können Sie verschiedene Stickdesigns kombinieren (siehe unten).  
 Combinez différents motifs de broderie, comme illustré ci-dessous, afin de profiter au mieux des joies de la broderie.  
 Zoals hieronder aangegeven kunt u diverse borduurpatronen combineren, voor nog meer borduurplezier.  
 Combinando vari motivi, come illustrato di seguito, ricamare diventa ancora più divertente.  
 Combine diferentes diseños de bordado, de la forma mostrada a continuación, para disfrutar aún más del bordado.  
 Combine vários padrões de bordado, como mostrado abaixo, para aumentar o seu prazer de bordar.  
 Чтобы получить красивые и оригинальные композиции, можно комбинировать различные рисунки, как показано ниже.



No.16 x 2 + No.17 x 2



No.8 + No.9 x 2



No.3 x 2

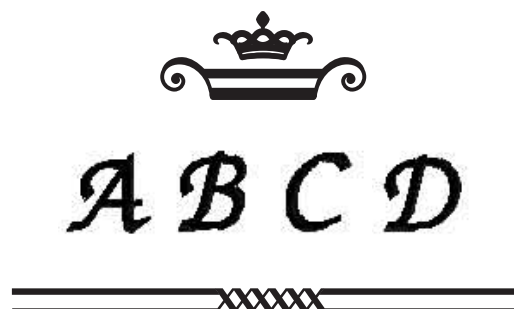

No.14 + 15



No.12 x 2

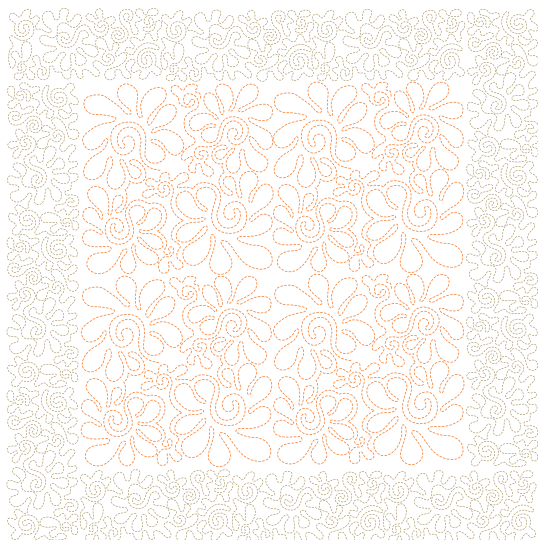

No.2 × 4 + No.14 × 12

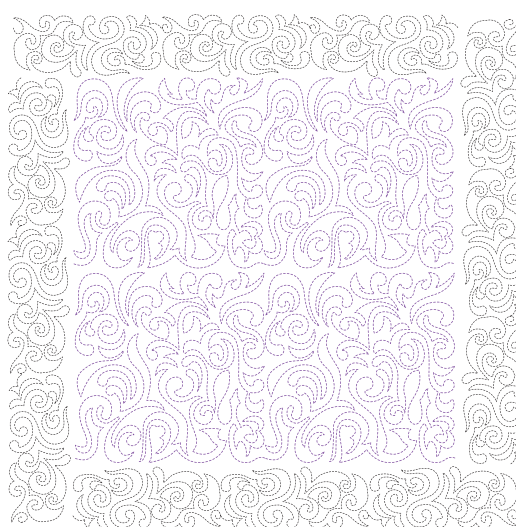

No.8 × 4 + No.16 × 12

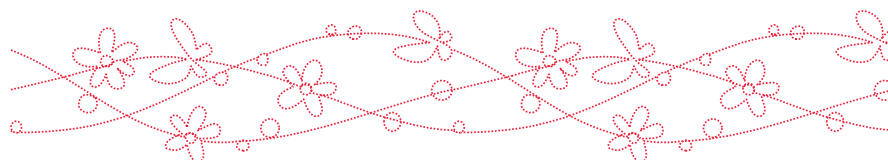

No.17 × 2



No.2 + No.27 × 2











































































No.6 + No.10 + No.19





















































No.2 + No.28 × 2

**Color Thread Conversion Chart**  
**Tableau de conversion des fils de couleur**  
**Tabella di conversione dei colori dei filati**  
**Tabela de conversão das cores de linha**

**Stickgarn-Farbtabelle**  
**Omzettingstabel voor garen kleuren**  
**Tabla de conversión de hilos de color**  
**Таблица преобразования цветов нитей**

	Color Name / Name der Farbe / Nom de la couleur / Kleur naam / Nome del colore / Nombre de color / Nome da cor / Наименование цвета	Embroidery	Country	Madeira Polyneon	Madeira Rayon	Sulky	R.A. Polyester
1	Black / Schwarz / Noir / Zwart / Nero / Negro / Preto / Черный	 900	 100	1800	1000	1005	5596
2	White / Weiss / Blanc / Wit / Bianco / Blanco / Branco / Белый	 001	 000	1801	1002	1001	5597
3	Red / Rot / Rouge / Rood / Rosso / Rojo / Vermelho / Красный	 800	 149	1637	1037	1037	5678
4	Pink / Rosa / Rose / Rose / Rosa / Rosado / Cravo / Розовый	 085	 155	1921	1108	1224	5523
5	Deep Rose / Tiefrot / Rose foncé / Roserood / Rosa Intenso / Rosa Intenso / Rosa-carregado / Темно-розовый	 086	 024	1721	1117	1154	9168
6	Flesh Pink / Fleischfarben / Rose chair / Lichtrose / Rosa Carne / Rosa Claro / Rosa pêssego / Свежий розовый	 124	 152	1915	1015	1064	5677
7	Dark Fuchsia / Dunkelviolett / Fuchsia foncé / Donker Fuchsia Paars / Fuchsia Scuro / Fúscia Oscuro / Vermelho fúscia escuro / Цвет темной фуксии	 107	 126	1984	1383	1533	5804
8	Vermillion / Zinnoberrot / Vermillion / Vermil Joen / Rosso Vermiglio / Bermellon / Vermelho / Багряный	 030	 148	1779	1179	1184	9023
9	Carmine / Karminrot / Carmin / Carmijn / Rosso Carminio / Carmin / Carmim / Карминный	 807	 158	1986	1081	1511	5561
10	Royal Purple / Königsapur / Pourpre royal / Dieppaars / Rosso-Violaceo / Violeta Real / Púrpura real / Яркий пурпурный	 869	 636	1788	1188	1192	5681
11	Magenta / Magenta / Magenta / Magenta / Magenta / Фуксин	 620	 625	1710	1319	1191	5592
12	Salmon Pink / Lachsrosa / Rose saumon / Zalmrose / Rosa Salmone / Rosa Salmon / Cravo salmão / Оранжево-розовый	 079	 122	1816	1317	1225	5773
13	Amber Red / Bernsteinrot / Rouge ambre / Amber Rood / Rosso Ambra / Rojo Ambar / Vermelho-âmbar / Янтарно-красный	 333	 212	1942	1341	1119	5591
14	Lemon Yellow / Zitronengelb / Jaune citron / Citro Engeel / Giallo Limone / Amarillo Limon / Amarelo limão / Лимонно-желтый	 202	 342	1623	1023	1067	5625
15	Yellow / Gelb / Jaune / Geel / Giallo / Amarillo / Amarelo / Желтый	 205	 043	1980	1068	1187	5860
16	Harvest Gold / Erntegold / Or blé / Oogst Kleurig Goud / Giallo Grano / Amarillo Trigo / Ouro trigo / Желто-золотистый	 206	 334	1971	1024	1124	5770
17	Orange / Orange / Orange / Oranje / Arancio / Naranja / Laranja / Оранжевый	 208	 335	1951	1137	1024	5694
18	Pumpkin / Kürbisgelb / Citrouille / Pompoen / Giallo Zucca / Calabaza / Abóbora / Тыквенный	 126	 322	1952	1155	1065	5630
19	Tangerine / Mandarinenorange / Tangerine / Felorange / Mandarino / Tangerina / Tangerina / Мандаринный цвет	 209	 336	1965	1078	1078	5518
20	Cream Brown / Braun Weiss / Brun crème / Creme Bruin / Nocciaola / Marron Crema / Marrom creme / Кремовый	 010	 331	1866	1022	1061	5761
21	Cream Yellow / Gelblich Weiss / Jaune crème / Cremegeel / Giallo Crema / Amarillo Crema / Amarelo creme / Кремово-желтый	 812	 370	1861	1349	1135	5564
22	Khaki / Khakibraun / Kaki / Khaki / Kaki / Saqui / Saqui / Цвет хаки	 348	 242	1939	1255	1055	5636
23	Deep Gold / Tiefgold / Or foncé / Diepgoud / Oro Scuro / Amarillo Oro / Ouro velho / Глубокий золотой	 214	 354	1772	1172	1025	5770
24	Brass / Messingfarben / Cuivre / Koper / Ottone / Bronze / Latão / Цвет латуни	 328	 404	1791	1192	1159	9109
25	Linen / Leinen Farbig / Drap / Linnen / Lino / Lino / Linho / Лняной	 307	 025	1682	1149	1082	5635
26	Dark Brown / Dunkelbraun / Brun sombre / Donker Bruin / Marrone Scuro / Marron Oscuro / Marron escuro / Темно-коричневый	 058	 717	1859	1130	1129	5637
27	Reddish Brown / Rotbraun / Brun rougeâtre / Rossing Bruin / Marrone Bruciato / Marron Rojizo / Marrom-avermelhado / Красно-коричневый	 337	 264	1753	1253	1021	5781
28	Clay Brown / Lehm Braun / Brun argile / Kleibruin / Marrone Argilla / Marron Tierra / Marrom barro / Коричневый	 339	 224	1621	1021	1158	5590
29	Beige / Beige / Beige / Beige / Beige / Beige / Bege / Бежевый	 843	 012	1738	1138	1127	5598
30	Warm Gray / Warmgrau / Gris vif / Warm Grijs / Grigio Caldo / Gris Caliente / Cinza quente / Теплый серый	 399	 706	1860	1085	1218	9126
31	Russet Brown / Rotbraun / Brun roussâtre / Roodbruin / Ruggine / Marron Bermejo / Marrom ruivo / Желто-коричневый	 330	 414	1726	1194	1126	5702
32	Light Brown / Hellbraun / Brun clair / Licht Bruin / Marrone Chiaro / Marron Claro / Marrom claro / Светло-коричневый	 323	 255	1729	1056	1128	5789
33	Seacrest / Blassgrün / Vert pâle / Blauw Groen / Cresta Di Mare / Verde Celadon / Azul marinho / Сероголубой	 542	 505	1647	1219	1077	5578
34	Mint Green / Pfefferminzgrün / Vert menthe / Munt Groen / Verde Menta / Verde Menta / Verde hortelã / Мятный зеленый	 502	 461	1702	1302	1047	5511
35	Leaf Green / Blattgrün / Vert feuille / Bladgroen / Verde Prato / Verde De Hoja / Verde folha / Цвет зеленой лисы	 509	 463	1749	1050	1510	5514
36	Olive Green / Olivgrün / Vert olive / Olijf Groen / Verde Oliva / Verde Oliva / Verde oliva / Зеленый оливковый	 519	 476	1904	1396	1174	5502

	Color Name / Name der Farbe / Nom de la couleur / Kleur naam / Nome del colore / Nombre de color / Nome da cor / Наименование цвета	Embroidery	Country	Madeira Polyneon	Madeira Rayon	Sulky	R.A. Polyester
37	Dark Olive / Dunkelolivgrün / Olive foncé / Donker Olijf / Oliva Scuro / Verde Oliva Oscuro / Verde-oliva escuro / Темно-оливковый	 517	 473	1769	1156	1156	9122
38	Teal Green / Blaugrün / Vert sarcelle / Taling Groen / Verde Anatra / Verde Azulado / Azul turquesa / Опалово-зеленый	 534	 483	1879	1298	1503	5751
39	Emerald Green / Emerald Grün / Vert émeraude / Smaragd Groen / Verde Smeraldo / Verde Esmeralda / Verde-esmeralda / Изумрудный	 507	 485	1750	1250	1079	5508
40	Deep Green / Dunkelgrün / Vert foncé / Diepgroen / Verde Intenso / Verde Intenso / Verde-carregado / Темно-зеленый	 808	 467	1703	1370	1208	5615
41	Fresh Green / Frischgrün / Vert frais / Licht Groen / Verde Mela / Verde Fresco / Verde-fresco / Цвет свежей зелени	 027	 442	1706	1102	1209	9153
42	Lime Green / Limonengrün / Vert tilleul / Limoen Groen / Verde Tiglio / Verde Lima/ Verde lima / Лаймовый зеленый	 513	 444	1848	1049	1177	5622
43	Moss Green / Moosgrün / Vert mousse / Mosgroen / Verde Muschio / Verde Musgo / Verde musgo / Серо-зеленый	 515	 446	1770	1369	1176	9091
44	Blue / Blau / Bleu / Blauw / Azzurro / Azul / Azul / Синий	 405	 586	1829	1177	1076	5684
45	Ultra Marine / Ultra Marin / Outremer / Ultra Marijn / Blu Oltremare / Azul De Ultramar / Azul ultramarinho / Ультрамарин	 406	 575	1842	1076	1042	5736
46	Light Blue / Hellblau / Bleu clair / Licht Blauw / Celeste / Azul Claro / Azul claro / Светло-голубой	 017	 150	1932	1132	1074	5683
47	Sky Blue / Himmelblau / Bleu ciel / Hemels Blauw / Azzurro Cielo / Celeste / Azul celeste / Лазурь	 019	 512	1828	1029	1196	5506
48	Electric Blue / Elektrischblau / Bleu électrique / Staal Blauw / Blu Elettrico / Azul Electrico / Azul eléctrico / Электрик	 420	 564	1797	1297	1250	5829
49	Peacock Blue / Pfauenblau / Bleu paon / Pauwen Blauw / Blu Pavone / Azul Pavo Real / Azul pavão / Переличатый синий	 415	 057	1652	1252	1206	5810
50	Prussian Blue / Berliner Blau / Bleu de Prusse / Pruisisch Blauw / Blu Di Prussia / Azul De Prusia / Azul da prussia / Берлинская лазурь	 007	 588	1767	1166	1535	5737
51	Cornflower Blue / Kornblumenblau / Bleu centauree / Koren Bloemen Blauw / Blu Fior-Daliso / Azul Centaura / Azul suave / Васильковый	 070	 015	1830	1335	1028	5601
52	Light Lilac / Helllila / Lilas clair / Licht Lila / Lilla Chiaro / Lila Suave / Lilás claro / Светло-сиреневый	 810	 133	1911	1031	1121	9016
53	Lilac / Lila / Lilas / Lila / Lilla / Lila / Lilás / Сиреневый	 612	 623	1831	1080	1080	9009
54	Violet / Violet / Violet / Violet / Violetto / Violeta / Violeta / Фиолетовый	 613	 624	1631	1033	1194	5588
55	Purple / Purpur / Pourpre / Paars / Viola / Purpura / Púrpura / Пурпурный	 614	 635	1880	1122	1122	5554
56	Lavender / Lavendel / Lavande / Lavendel / Lavanda / Lavanda / Lavanda / Лавандовый	 804	 604	1630	1261	1193	5586
57	Wisteria Violet / Wistaria Violet / Violet glycine / Blauwe Regen Paars / Glicine / Violeta Vistaria / Violeta-licinia / Цвет глицинии	 607	 003	1943	1311	1032	5587
58	Pewter / Zinngrau / Étain / Tinkleurig / Peltro / Peltre / Estanho / Цвет пьютера	 704	 745	1840	1041	1041	9114
59	Dark Gray / Dunkelgrau / Gris sombre / Donker Grijs / Grigio Scuro / Gris Oscuro / Cinza escuro / Темно-серый	 707	 747	1841	1241	1220	5565
60	Silver / Silber / Argent / Zilver / Argento / Plata / Prata / Серебряный	 005	 020	1812	1087	1011	5640
61	Gray / Grau / Gris / Grijs / Grigio / Gris / Cinza / Серый	 817	 734	1640	1118	1219	5782
62	----->						
63	-----						
64	~~~~~ ~~~~~						
65	NOT DEFINED / NICHT DEFINIERT / NON DEFINI / NIET GEDEFINIEERD / NON DEFINITO / SIN DEFINIR / NÃO DEFINIDO / НЕ ОПРЕДЕЛЕНО						





















**Color Thread Conversion Chart**  
**Tableau de conversion des fils de couleur**  
**Tabella di conversione dei colori dei filati**  
**Tabela de conversão das cores de linha**

**Stickgarn-Farbtabelle**  
**Omzettingstabel voor garen kleuren**  
**Tabla de conversión de hilos de color**  
**Таблица преобразования цветов нитей**

- Note:** *The conversion chart is based on Embroidery thread. The color shades may vary with the different brands listed on the chart. If unsure of a particular color(s), please sew test. Robison Anton (R.A.), Madeira and Sulky are respectively registered trademarks. Actual colors may vary slightly from the chart.*
- Hinweis:** *Die Garntabelle basiert auf Brother Stickgarn. Die Farbschattierungen können je nach unterschiedlichen, in der Tabelle aufgeführten Marken abweichen. Wenn Sie sich bei bestimmten Farben nicht sicher sind, sticken Sie bitte eine Probe. Robison Anton (R.A.), Madeira und Sulky sind eingetragene Warenzeichen. Die tatsächlichen Farben können leicht von der Tabelle abweichen.*
- Remarque:** *Le tableau de conversion est basé sur le fil de broderie. Les nuances de couleur peuvent varier en fonction des marques énumérées dans le tableau. En cas de doute sur un coloris, faites un essai de couture. « Robison Anton (R.A.) », « Madeira » et « Sulky » sont des marques déposées respectives. Les couleurs réelles risquent d'être légèrement différentes de celles du tableau.*
- Opmerking:** *Het omzettingsschema is gebaseerd op het gebruik van borduurgarens. De kleurtinten kunnen enigzins afwijken voor de diverse merken in het schema. Indien u niet zeker bent van de juiste kleur(en), borduur dan eerst een stukje op proef. De namen Robison Anton (R.A.), Madeira en Sulky zijn allemaal gedeponeerde handelsmerken. De oorspronkelijke kleurtinten kunnen iets afwijken van de weergave.*
- Nota:** *La tabella di conversione è in funzione del filo da ricamo. Le tonalità cromatiche possono variare secondo le differenti marche elencate nella tabella. In caso di dubbio su un particolare colore o su più colori si raccomanda di eseguire una prova di cucito. Robison Anton (R.A.), Madeira e Sulky sono marchi di fabbrica registrati. I colori effettivi possono variare lievemente rispetto a quelli della tabella.*
- Nota:** *La tabla de conversión está basada en hilo de bordar. Los tonos de color podrán variar con las diferentes marcas enumeradas en la tabla. Si tiene dudas sobre un color o colores en particular, haga un cosido de prueba. Robison Anton (R.A.), Madeira y Sulky son marcas registradas respectivamente. Los colores verdaderos podrán variar ligeramente con respecto a los de la tabla.*
- Nota:** *A tabela de conversão é baseada na linha de bordar. As tonalidades das cores podem variar nas diferentes marcas listadas na tabela. Se não tiver certeza sobre uma determinada cor ou cores, faça o teste de costura. Robison Anton (R.A.), Madeira e Sulky são respectivamente marcas registradas. As cores reais podem variar um pouco da tabela.*
- Примечание:** *Таблица преобразования составлена на базе вышивальных нитей. Оттенки цветов могут варьироваться в зависимости от производителей, указанных в таблице. Если вы не уверены в выборе какого-то конкретного цвета, произведите пробную вышивку. Robison Anton (R.A.), Madeira и Sulky являются зарегистрированными товарными знаками. Реальные цвета могут несколько отличаться от представленных в таблице.*

Font Name Chart  
 Tableau des noms de polices  
 Tabella nomi dei font  
 Quadro de nomes de fontes

Tabelle der Schriftarten  
 Overzicht lettertypen  
 Diagrama de nombre de las fuentes  
 Таблица названий шрифтов

	Font Key/ Schriftarttaste/ Touche de police/ Lettertypetoets/ Tasto font/ Clave de las fuentes/ Tecla da fonte/ Кнопка шрифта	Font Name/ Schriftartname/ Nom de la police/ Lettertype/ Nome font/ Nombre de la fuente/ Nome da fonte/ Название шрифта
1		Künstlerschreibschrift
2		Block 01
3		Serif 01
4		Brussels Demi Outline
5		Serif 02
6		Gothic 01
7		Calgary MediumItalic
8		Sicilia Light Italic
9		Luedickital
10		Toms Handwritten
11		Istanbul
12		San Diego
13		Los Angeles
14		Saipan
15		Helsinki Nallow Small
16		Riesa S
17		Germany S
18		Script 01 SR
19		Utah Bold Cyrillic
20		PC Tennessee Bold Cyrillic



English  
German  
French  
Dutch  
Italian  
Spanish  
Portuguese-BR  
Russian

882-T51  
Printed in Taiwan



XG1506-001