

Operation Manual

Embroidery Machine

Product Code: 882-W80/W82



Be sure to read this document before using the machine.
We recommend that you keep this document nearby for future reference.

INTRODUCTION

Thank you for purchasing this machine. Before using this machine, carefully read the "IMPORTANT SAFETY INSTRUCTIONS", and then study this manual for the correct operation of the various functions.

In addition, after you have finished reading this manual, store it where it can quickly be accessed for future reference.

Failure to follow these instructions may result in an increased risk of personal injury or damage to property, including through fire, electrical shock, burns or suffocation.

IMPORTANT SAFETY INSTRUCTIONS

Please read these safety instructions before attempting to use the machine.

DANGER

- To reduce the risk of electric shock

1 Always unplug the machine from the electrical outlet immediately after using, cleaning, when making any user servicing adjustments mentioned in this manual, or if you are leaving the machine unattended.

WARNING

- To reduce the risk of burns, fire, electric shock, or injury to persons.

2 Always unplug the machine from the electrical outlet when removing covers, or when making any adjustments mentioned in the instruction manual.

- To unplug the machine, switch the machine to the symbol "O" position to turn it off, then grasp the plug and pull it out of the electrical outlet. Do not pull on the cord.
- Plug the machine directly into the electrical outlet. Do not use an extension cord.
- Always unplug your machine if the power is cut.

3 Electrical Hazards:

- This machine should be connected to an AC power source within the range indicated on the rating label. Do not connect it to a DC power source or inverter. If you are not sure what kind of power source you have, contact a qualified electrician.
- This machine is approved for use in the country of purchase only.

4 Never operate this machine if it has a damaged cord or plug, if it is not working properly, if it has been dropped or damaged, or water is spilled on the unit. Return the machine to the nearest authorized Brother dealer for examination, repair, electrical or mechanical adjustment.

- While the machine is stored or in use if you notice anything unusual, such as an odor, heat, discoloration or deformation, stop using the machine immediately and unplug the power cord.
- When transporting the machine, be sure to carry it by its handle. Lifting the machine by any other part may damage the machine or result in the machine falling, which could cause injuries.
- When lifting the machine, be careful not to make any sudden or careless movements, otherwise you may injure your back or knees.

5 Always keep your work area clear:

- Never operate the machine with any air openings blocked. Keep ventilation openings of the machine free from the build up of lint, dust, and loose cloth.
- Never drop or insert any object into any opening.
- Do not operate where aerosol (spray) products are being used or where oxygen is being administered.
- Do not use the machine near a heat source, such as a stove or iron; otherwise, the machine, power cord or garment being embroidered may ignite, resulting in fire or an electric shock.
- Do not place this machine on an unstable surface, such as an unsteady or slanted table, otherwise the machine may fall, resulting in injuries.

6 Special care is required when embroidering:

- Always pay close attention to the needle. Do not use bent or damaged needles.
- Keep fingers away from all moving parts. Special care is required around the machine needle.
- Switch the machine to the symbol "O" position to turn it off when making any adjustments in the needle area.
- Do not use a damaged or incorrect needle plate, as it could cause the needle to break.
- Do not push or pull the fabric when embroidering.

7 This machine is not a toy:

- Your close attention is necessary when the machine is used by or near children.
- The plastic bag that this machine was supplied in should be kept out of the reach of children or disposed of. Never allow children to play with the bag due to the danger of suffocation.
- Do not use outdoors.

8 For a longer service life:

- When using and storing this machine, avoid direct sunlight and high humidity locations. Do not use or store the machine near a space heater, iron, halogen lamp, or other hot objects.
- Use only neutral soaps or detergents to clean the case. Benzene, thinner, and scouring powders can damage the case and machine, and should never be used.
- Always consult the Operation Manual when replacing or installing any assemblies, the presser feet, needle, or other parts to assure correct installation.

9 For repair or adjustment:

- If the light unit is damaged, it must be replaced by an authorized Brother dealer.
- In the event a malfunction occurs or adjustment is required, first follow the troubleshooting table in the back of the Operation Manual to inspect and adjust the machine yourself. If the problem persists, please consult your local authorized Brother dealer.

Use this machine only for its intended use as described in the manual.

Use accessories recommended by the manufacturer as contained in this manual.

Use only the mouse designed specifically for this machine.

The contents of this manual and specifications of this product are subject to change without notice.

For additional product information and updates, visit our website at www.brother.com

SAVE THESE INSTRUCTIONS

This machine is intended for household use.

FOR USERS IN COUNTRIES EXCEPT CENELEC COUNTRIES

This appliance is not intended for use by persons (including children) with reduced physical, sensory or mental capabilities, or lack of experience and knowledge, unless they have been given supervision or instruction concerning use of the appliance by a person responsible for their safety. Children should be supervised to ensure that they do not play with the appliance.

FOR USERS IN CENELEC COUNTRIES

This appliance can be used by children aged from 8 years and above and persons with reduced physical, sensory or mental capabilities or lack of experience and knowledge if they have been given supervision or instruction concerning use of the appliance in a safe way and understand the hazards involved. Children shall not play with the appliance. Cleaning and user maintenance shall not be made by children without supervision.

FOR USERS IN THE UK, EIRE, MALTA AND CYPRUS ONLY

IMPORTANT

- In the event of replacing the plug fuse, use a fuse approved by ASTA to BS 1362, i.e. carrying the  mark, rating as marked on plug.
- Always replace the fuse cover. Never use plugs with the fuse cover omitted.
- If the available electrical outlet is not suitable for the plug supplied with this equipment, you should contact your authorized Brother dealer to obtain the correct lead.

Federal Communications Commission (FCC) Supplier's Declaration of Conformity (For U.S.A. Only)

Responsible Party: Brother International Corporation
200 Crossing Boulevard
P.O. Box 6911
Bridgewater, NJ 08807-0911
USA
TEL : (908) 704-1700

declares that the product

Product Name: Brother Embroidery Machine
Model Number: XE1

This device complies with Part 15 of the FCC Rules. Operation is subject to the following two conditions: (1) this device may not cause harmful interference, and (2) this device must accept any interference received, including interference that may cause undesired operation.

This equipment has been tested and found to comply with the limits for a Class B digital device, pursuant to Part 15 of the FCC Rules. These limits are designed to provide reasonable protection against harmful interference in a residential installation. This equipment generates, uses, and can radiate radio frequency energy and, if not installed and used in accordance with the instructions, may cause harmful interference to radio communications. However, there is no guarantee that interference will not occur in a particular installation. If this equipment does cause harmful interference to radio or television reception, which can be determined by turning the equipment off and on, the user is

encouraged to try to correct the interference by one or more of the following measures:

- Reorient or relocate the receiving antenna.
- Increase the separation between the equipment and receiver.
- Connect the equipment into an outlet on a circuit different from that to which the receiver is connected.
- Consult the authorized Brother dealer or an experienced radio/TV technician for help.
- This transmitter must not be co-located or operated in conjunction with any other antenna or transmitter.

Important

Changes or modifications not expressly approved by Brother Industries, Ltd. could void the user's authority to operate the equipment.

This equipment complies with FCC/IC radiation exposure limits set forth for an uncontrolled environment and meets the FCC radio frequency (RF) Exposure Guidelines and RSS-102 of the IC radio frequency (RF) Exposure rules. This equipment has very low levels of RF energy that it deemed to comply without maximum permissive exposure evaluation (MPE).

For Users in Canada

This device complies with Industry Canada's licence-exempt RSSs. Operation is subject to the following two conditions:

- (1) This device may not cause interference; and
- (2) This device must accept any interference, including interference that may cause undesired operation of the device.

This equipment complies with FCC/IC radiation exposure limits set forth for an uncontrolled environment and meets the FCC radio frequency (RF) Exposure Guidelines and RSS-102 of the IC radio frequency (RF) Exposure rules. This equipment has very low levels of RF energy that it deemed to comply without maximum permissive exposure evaluation (MPE).

For Users in Mexico

The operation of this equipment is subject to the following two conditions:

- (1) it is possible that this equipment or device may not cause harmful interference, and
- (2) this equipment or device must accept any interference, including interference that may cause undesired operation.

Declaration of Conformity (Europe and Turkey only)

We, Brother Industries, Ltd. 15-1 Naeshiro-cho, Mizuho-ku, Nagoya 467-8561 Japan declare that this product is in conformity with the essential requirements of all relevant directives and regulations applied within the European Community.

The Declaration of Conformity (DoC) can be downloaded from Brother Solutions Center.

Visit <http://s.brother/cpeab/> and:

- click "Manuals"
- select your model
- click "Declaration of Conformity"
- click "Download"

Your Declaration will be downloaded as a PDF file.

Declaration of Conformity for RE Directive 2014/53/ EU (CENELEC and Turkey only) (Applicable to models with radio interfaces)

We, Brother Industries, Ltd. 15-1 Naeshiro-cho, Mizuho-ku, Nagoya 467-8561 Japan declare that these products are in conformity with the provisions of the RE Directive 2014/53/EU. A copy of the Declaration of Conformity can be downloaded by following the instructions in the Declaration of Conformity (Europe and Turkey only) section.

Wireless LAN (Models with Wireless LAN function only)

This machine supports wireless interface.

Frequency band(s): 2400-2483.5 MHz

Maximum radio-frequency power transmitted in the frequency band(s): Less than 20 dBm(e.i.r.p)

For Users in Norway

This subsection does not apply for the geographical area within a radius of 20 km from the centre of Ny-Alesund on Svalbard.

Dette underavsnittet gjelder ikke for det geografiske området innenfor en radius av 20 km fra sentrum av Ny-Ålesund på Svalbard.

For Users in Thailand

This telecommunication equipment conforms to NTC technical requirement.

Terms of Use

IMPORTANT-PLEASE READ CAREFULLY:

This Terms of Use ("Agreement") is a legal agreement between Brother Industries, Ltd. ("Company") and you that governs your use of any Software, installed on or made available by Company for use with sewing or craft products ("Company Product"). The term of "Software" means any and all contents data, design data, data format, firmware of Company Product, and PC application or mobile device application.

By using the Software and Company Product, you shall be deemed to have agreed to be bound by the terms of this Agreement. If you do not agree to the terms of this Agreement, Company is unwilling to license the Software and you are not allowed to use the Software. Amendments and supplements to this Agreement may be attached to the Software.

An individual who accepts this Agreement on behalf of an entity represents to Company that he or she has the legal right to enter into a binding legal agreement for that entity.

Terms and Conditions

1 Grant of License.

- 1.1 Subject to this Agreement, Company hereby grants you a personal, non-exclusive, non-transferable and revocable license to use the Software only within the Company Product.
- 1.2 Your right to use of the Software is licensed and not sold, and solely for your use subject to this Agreement. Company or its suppliers retains all right, title, and interest relating to Software, including without limitation all intellectual property rights relating thereto.

2 Restrictions

- 2.1 Except as expressly set out in this Agreement or as required by any local law, you shall undertake:
 - 2.1.1 not to disassemble, de-compile, reverse engineer, translate or otherwise attempt to learn the source code of the Software (including the data or contents created by using the Company Product or contents editing application software; hereinafter the same shall apply in this Clause 2.);
 - 2.1.2 not to create derivative works based on the whole or any part of the Software;
 - 2.1.3 not to distribute, provide or make available the Software in any form, in whole or in part to any person without prior written consent from Company;
 - 2.1.4 not to copy the Software, except where such copying is incidental to normal use of the Software with Company Product or where it is necessary for the purpose of back-up or operational security;
 - 2.1.5 not to transfer, rent, lease, sub-license, loan, translate, merge, adapt, vary, alter or modify, the whole or any part of the Software nor permit the Software or any

part of it to be combined with, or become incorporated in, any other programs;

- 2.1.6 to include Company's copyright notice and this Agreement on all entire and partial copies of the Software; and
- 2.1.7 not to use the Software for any purpose (including, but not limited to, use with unauthorized sewing/craft products or software) other than as provided under Clause 1 of this Agreement.

3 No warranty

TO THE EXTENT PERMISSIBLE BY APPLICABLE LAW, THIS SOFTWARE IS PROVIDED TO YOU "AS IS" WITHOUT WARRANTIES OR CONDITIONS OF ANY KIND, WHETHER ORAL OR WRITTEN, EXPRESS OR IMPLIED. COMPANY SPECIFICALLY DISCLAIMS ANY IMPLIED WARRANTIES OR CONDITIONS OF MERCHANTABILITY, SATISFACTORY QUALITY, NON-INFRINGEMENT AND/OR FITNESS FOR A PARTICULAR PURPOSE.

4 Limitation of liability

- 4.1 COMPANY SHALL NOT BE LIABLE TO YOU, ITS END-USERS OR ANY OTHER ENTITY FOR ANY LOSS OF PROFITS OR INCOME OR SAVINGS, LOSS OF DATA, INTERRUPTION OF USE, OR CONSEQUENTIAL, INCIDENTAL, SPECIAL, PUNITIVE OR INDIRECT DAMAGES INCURRED BY SUCH PARTY (WHETHER IN AN ACTION IN CONTRACT OR TORT), EVEN IF COMPANY HAS BEEN ADVISED OF THE POSSIBILITY OF SUCH DAMAGES, ARISING OUT OF OR RELATING TO THE SOFTWARE, SUPPORT SERVICE OR THIS AGREEMENT. THESE LIMITATIONS SHALL APPLY TO THE MAXIMUM EXTENT ALLOWED BY APPLICABLE LAW NOTWITHSTANDING ANY FAILURE OF ESSENTIAL PURPOSE OF ANY LIMITED REMEDY.
- 4.2 NOTWITHSTANDING THE CLAUSE 3 OR 4.1 HEREOF, THIS AGREEMENT DOES NOT PURPORT TO EXCLUDE OR RESTRICT COMPANY'S LIABILITY FOR DEATH OR PERSONAL INJURY RESULTING FROM NEGLIGENCE OR LIMIT THE STATUTORY RIGHTS OF A CONSUMER.

5 Termination

- 5.1 Company shall have the right to terminate this Agreement at any time by providing a written notice to you if you commit a material breach of any terms of this Agreement and fail to immediately rectify such breach upon Company's request.
- 5.2 Upon termination for any reason all rights granted to you under this Agreement shall cease, you shall cease all activities authorized by this Agreement and you shall immediately delete or remove the Software from all computer equipment in your possession and delete or destroy all copies of the Software or its derivative works in your possession. In addition to the above, you shall delete contents

or design data created by you from the Company Product in your possession.

6 Miscellaneous terms

- 6.1 You shall not export or re-export the Software or any copy or adaptation thereof in violation of any applicable laws or regulations.
- 6.2 You shall not assign all or any part of this Agreement to any third party or any interest therein, without prior written consent of Company. A change of control or reorganization of you pursuant to a merger, sale of assets or stock shall be deemed to be an assignment under this Agreement.
- 6.3 You agree that a breach of this Agreement will cause irreparable injury to Company for which monetary damages would not be an adequate remedy and Company shall be entitled to seek equitable relief in addition to any remedies it may have hereunder or at law without a bond, other security, or proof of damages.
- 6.4 If any provisions of this Agreement shall be declared or determined as void or unenforceable by a court of competent jurisdiction, such provisions shall be severable and independent from the other provisions of this Agreement and the validity of the other provisions and of the entire Agreement shall not be affected thereby.
- 6.5 This Agreement, together with all exhibits or other attachments referenced herein, constitutes the entire agreement between the parties on the subject matter hereof, and supersedes all proposals, oral and written, between the parties on this subject.
- 6.6 If Company fails to insist that you perform any of your obligations under this Agreement, or if Company does not enforce any rights against you, or if Company delay in doing so, that will not mean that Company have waived any rights against you and will not mean that you do not have to comply with those obligations. If Company does waive a default by you, Company will only do so in writing, and that will not mean that Company will automatically waive any later default by you.
- 6.7 The laws of the state or country where you live (or, if a business, where your principal place of business is located) govern all claims and disputes concerning the Software or this Agreement.

TRADEMARKS

Secure Digital (SD) Card is a registered trademark or a trademark of SD-3C, LLC.

CompactFlash is a registered trademark or a trademark of Sandisk Corporation.

Memory Stick is a registered trademark or a trademark of Sony Corporation.

SmartMedia is a registered trademark or a trademark of Toshiba Corporation.

MultiMediaCard (MMC) is a registered trademark or a trademark of Infineon Technologies AG.

xD-Picture Card is a registered trademark or a trademark of Fuji Photo Film Co. Ltd.

This software is based in part on the work of the Independent JPEG Group.

WPA™ and WPA2™ are trademarks of Wi-Fi Alliance®.

Each company whose software title is mentioned in this manual has a Software License Agreement specific to its proprietary programs.

Any trade names and product names of companies appearing on Brother products, related documents and any other materials are all trademarks or registered trademarks of those respective companies.

OPEN SOURCE LICENSING REMARKS

This product includes open-source software.

To see the open source licensing remarks, please go to the manual download section on your model's home page of Brother Solutions Center at "<http://s.brother/cpeab/>".

CONTENTS

Chapter 1 Getting Ready	9	Chapter 3 Advanced Embroidery	69
NAMES OF MACHINE PARTS	10	VARIOUS EMBROIDERING FUNCTIONS	70
Included Accessories	11	Basting Embroidery	70
Accessories that are Included in Some Countries or Regions	12	Creating an Appliqué Piece	70
Options	13	MAKING EMBROIDERY ADJUSTMENTS	73
TURNING THE MACHINE ON/OFF	14	Adjusting Thread Tension	73
LCD SCREEN	15	Adjusting the Bobbin Case (with No Color on the Screw)	75
Using the Machine Settings Key	16	Using the Automatic Thread Cutting Function (End Color Trim).....	76
Using the Machine Help	19	Using the Thread Trimming Function (Jump Stitch Trim)	76
WIRELESS NETWORK CONNECTION FUNCTIONS	20	Adjusting the Embroidery Speed	77
Enabling a Wireless Network Connection	20	Changing the Thread Color Display	77
Setting Up the Wireless Network Connection	21	Aligning the Pattern and the Needle	77
CONNECTING THE ACCESSORY TO THE MACHINE	23	Embroidering Linked Characters	78
Using a USB Mouse (Sold Separately)	23	USING THE MEMORY FUNCTION	80
WINDING/INSTALLING THE BOBBIN	23	Saving Embroidery Patterns	80
Winding the Bobbin.....	23	Retrieving Embroidery Patterns	80
Setting the Bobbin.....	26	EMBROIDERY APPLICATIONS	81
UPPER THREADING	28	Using a Frame Pattern To Make an Appliqué.....	81
Upper Threading.....	28	Embroidering Split Embroidery Patterns	82
CHANGING THE NEEDLE	30	Chapter 4 My Design Center	85
Chapter 2 Basic Embroidery	33	ABOUT MY DESIGN CENTER	86
BEFORE EMBROIDERING	34	PATTERN DRAWING SCREEN	86
Embroidery Step by Step	34	Before Creating Designs	88
About the Embroidery Unit	34	Drawing Lines	88
SELECTING PATTERNS	36	Drawing Regions	89
Selecting Embroidery Patterns	36	Using the Stamp Key	90
Selecting Character Patterns	38	Using the Erase Key	91
Selecting Frame Patterns	39	Using the Select Key	91
Combining Patterns	40	STITCH SETTINGS SCREEN	92
EDITING PATTERNS	42	Specifying Individual Stitch Settings	92
Previewing the Pattern	44	Specifying Global Stitch Settings	93
Changing the Size and the Density of the Pattern	44	Loading the Background Image	94
Creating Repeated Patterns	45	LINE CONVERSION	95
Embroidering the Pattern Repeatedly	47	Create a Pattern with Line Conversion	95
EDITING COLORS	49	ILLUSTRATION CONVERSION	97
Changing the Thread Color	49	Create a Pattern with Illustration Conversion	97
Finding New Color Schemes with the Color Shuffling Function	50	STIPLING	99
Thread Color Sorting	52	Basic Stippling with My Design Center	99
VIEWING THE EMBROIDERY SCREEN	53	Decorative Stitching around a Pattern in Embroidery (a Quilting Function)	101
PREPARING THE FABRIC	55	Chapter 5 Appendix	105
Attaching Iron-on Stabilizers (Backing) to the Fabric	55	CARE AND MAINTENANCE	106
Hooping the Fabric in the Embroidery Frame	56	Restrictions on Oiling	106
ATTACHING THE EMBROIDERY FRAME	58	Precautions on Storing the Machine	106
CONFIRMING THE PATTERN POSITION	59	Cleaning the Race	106
Checking the Needle Drop Point with the Embroidery Foot “W+” with LED Pointer	59	Cleaning the Cutter in the Bobbin Case Area	107
Displaying a Background Image	60	Changing Embroidery Foot “W+” with LED Pointer	107
Checking the Pattern Position	61	ADJUSTING THE SCREEN	108
EMBROIDERING A PATTERN	62	Touch Panel is Malfunctioning	108
Embroidering Attractive Finishes	62	TROUBLESHOOTING	109
Embroidering Patterns	63	Untangling Thread from beneath the Bobbin Winder Seat	109
Using Appliqués	64	List of Symptoms	110
ADJUSTMENTS DURING THE EMBROIDERY PROCESS	66	ERROR MESSAGES	113
If the Thread Breaks or the Bobbin Runs out of Thread During Embroidering	66	SPECIFICATIONS	116
Resuming Embroidery after Turning off the Power	67	UPGRADING YOUR MACHINE'S SOFTWARE	118
		INDEX	119

1

2

3

4

5



Chapter **1**

Getting Ready

Be sure to install the latest software.

Refer to "UPGRADING YOUR MACHINE'S SOFTWARE" on page 118.

<http://s.brother/cpeab/>

NAMES OF MACHINE PARTS

■ Main Parts

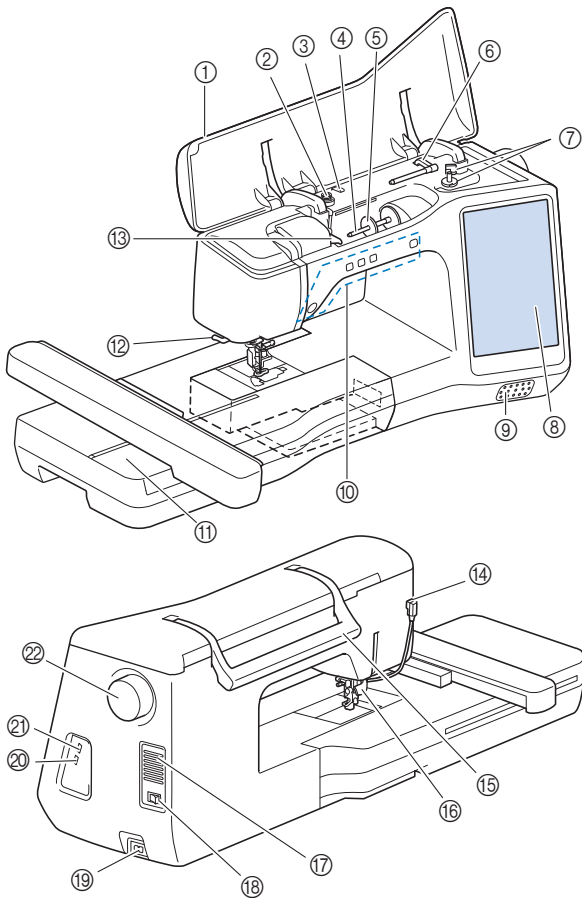

- ① **Top cover**
- ② **Pretension disk (page 24)**
- ③ **Thread guide for bobbin winding (page 24)**
- ④ **Spool pin (page 25)**
- ⑤ **Spool cap (page 23)**
- ⑥ **Supplemental spool pin (page 23)**
- ⑦ **Bobbin winder (page 23)**
- ⑧ **LCD (liquid crystal display) (page 15)**
- ⑨ **Speaker**
- ⑩ **Operation buttons (page 10)**
- ⑪ **Embroidery unit (page 35)**
- ⑫ **Thread cutter (page 29)**
- ⑬ **Thread guide plate (page 25)**
- ⑭ **Connector for the presser foot (page 108)**
- ⑮ **Handle**
Carry the machine by its handle when transporting the machine.
- ⑯ **Presser foot lever**
You cannot use the presser foot lever after the presser foot has been raised using  (Presser foot lifter button).
- ⑰ **Air vent**
The air vent allows the air surrounding the motor to circulate. Do not cover the air vent while the machine is being used.
- ⑱ **Main power switch (page 14)**
- ⑲ **Power cord receptacle (page 14)**
- ⑲ **USB port for mouse (page 23)**
- ⑲ **USB port**
- ⑲ **Handwheel**
Turn the handwheel toward you (counterclockwise) to raise and lower the needle.

■ Needle and Presser Foot Section

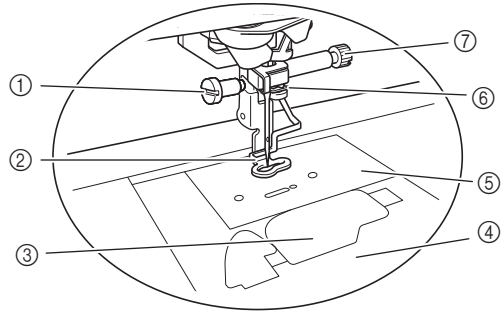



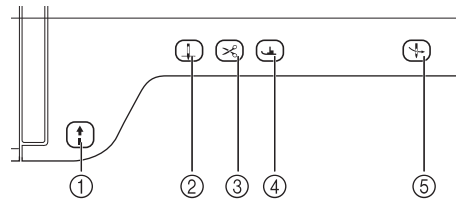

- ① **Screw for embroidery foot (page 108)**
- ② **Embroidery foot**
The embroidery foot helps control fabric flexibility for better stitch consistency.
- ③ **Bobbin cover (page 26)**
- ④ **Needle plate cover (page 27)**
- ⑤ **Needle plate (page 107)**
- ⑥ **Needle bar thread guide (page 29)**
- ⑦ **Needle clamp screw (page 31)**

■ Operation Buttons









- ① **“Start/Stop” button **
Press the “Start/Stop” button to start or stop the machine. The button changes color according to the machine’s operation mode.



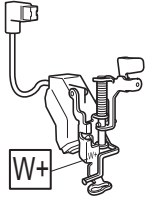
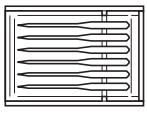

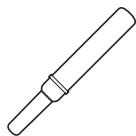



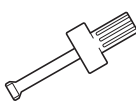
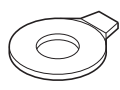

Green: The machine is ready to embroider or is embroidering.

Red: The machine is not ready to start embroidering.
- ② **Needle position button **
Press the needle position button to raise or lower the needle position. Pressing the button twice embroiders a single stitch.
- ③ **Thread cutter button **
Press the thread cutter button after embroidering to trim the excess thread.
- ④ **Presser foot lifter button **
Press the presser foot lifter button to lower the presser foot and apply pressure to the fabric. Press this button again to raise the presser foot.
- ⑤ **Automatic threading button **
Use the automatic threading button to automatically thread the needle.

Included Accessories

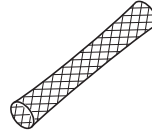
After opening the box, check that the following accessories are included. If any item is missing or damaged, contact your authorized Brother dealer.

	Part Name
	Part Code
	Embroidery foot "W+" with LED pointer (on machine)
	SA197 (U.S.A.) / SA197C (Canada) FLED1: XF4168-001 (Europe) FLED1AP: 115C05E700W (other areas)
	Needle set 75/11 6 needles: Ball point needle for embroidery
	XC6469-001
	Bobbin × 10 (One bobbin is in machine.)
	SA156 (Americas) SFB: XA5539-151 / 115J05E0001 (Europe) SFB: 115J05E7001 (other areas)
	Seam ripper
	XF4967-001
	Scissors
	XF2052-001
	Cleaning brush
	X59476-051
	Screwdriver (small)
	X55468-051
	Screwdriver (large)
	XC4237-021
	Disc-shaped screwdriver
	XC1074-051

	Part Name
	Part Code
	Spool cap (small)
	130013-154
	Spool cap (medium) × 2 (One spool cap is on machine.)
	X55260-153
	Spool cap (large)
	130012-054
	Thread spool insert (mini king thread spool)
	XA5752-121
	Vertical spool pin
	XC8619-052
	Spool felt (on machine)
	X57045-051
	Spool net × 2
	XA5523-050
	Embroidery needle plate cover
	XE5131-001
	Touch pen (stylus)
	XA9940-051
	Bobbin case (no color on the screw) (on machine)
	XF5790-101

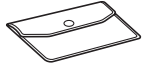
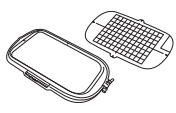
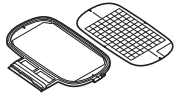
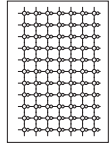
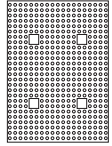
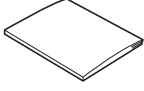
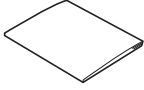

	Part Name
	Part Code
	Bobbin cover (on machine)
	XE8992-101
	Accessory bag
	XC4487-021
	Embroidery frame with decal set H 36 cm x W 24 cm (H 14 inches x W 9-1/2 inches)
	SA449S (Americas) EF95S: XH4465-001 / 115D05E0017 (Europe) EF95SAP: 115D05E7017 (other areas)
	Embroidery frame with decal set H 18cm x W 13cm (H 7 inches x W 5 inches)
	SA439S (Americas) EF75S: XH4464-001 / 115D05E0016 (Europe) EF75SAP: 115D05E7016 (other areas)
	Embroidery bobbin thread (#90, white)
	EBT-PE (Americas) EBT-PEN: XC5996-101 (Europe) EBT-PEN: 115G05E7002 (other areas)
	Embroidery positioning sticker sheets x 4
	SAEPS2 (U.S.A.) / SAEPS2C (Canada) EPS2: XG6749-001 / 115Z05E000E (Europe) EPS2CN: 115Z05E600E (China) EPS2: XF0763-001 (other areas)
	Lens calibration sheet
	XH4336-001
	Operation Manual
	This manual
	Quick Reference Guide
	XH3875-001 (Americas) XH3951-001 (other areas)

 **Memo**

- The screw for the embroidery foot is available through your authorized Brother dealer (Part code XA5904-051).
- Please visit “ <http://s.brother/cpeab/> ” to download documents.

Accessories that are Included in Some Countries or Regions

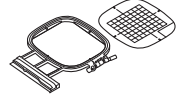
If these accessories are not included with your machine, these are available as optional accessories.

	Part Name
	Part Code
	Embroidery frame with decal set H 10 cm x W 10 cm (H 4 inches x W 4 inches)
	SA438S (Americas) EF74S: XH4463-001 / 115D05E0015 (Europe) EF74SAP: 115D05E7015 (other areas)
	Bobbin center pin and instruction sheet
	XF5048-001
	Stabilizer material
	SA519 (Americas) BM3: XG6683-001 / 115Z05E0007 (Europe) BM3CN: 115Z05E6007 (China) BM3: XE0806-001 (other areas)
	Bobbin clip x 10
	XE3060-001

 **Memo**

- Placing bobbin clips on bobbins helps prevent the thread from unwinding from the bobbin. In addition, snapping bobbin clips together allows the bobbins to be conveniently stored and prevents them from rolling around if they are dropped.

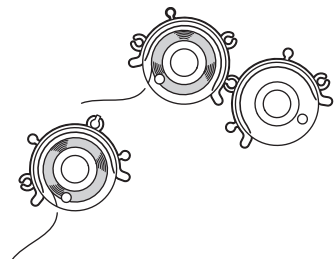



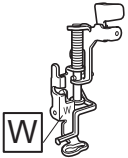
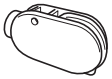

Options

The following are available as optional accessories to be purchased separately from your authorized Brother dealer.

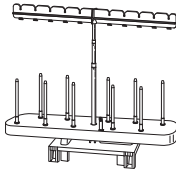
* These embroidery frames can be used for general embroidery but cannot be used with the application (My Design Snap).

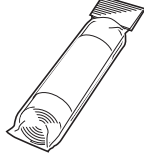
	Part Name
	Part Code
*	Embroidery frame set H 30 cm × W 20 cm (H 12 inches × W 8 inches)
	SA447 (Americas) EF92: XG6717-001 (Europe) EF92: 115D05E700Z (other areas)
	Embroidery frame with decal set H 24 cm × W 24 cm (H 9-1/2 inches × W 9-1/2 inches)
	SA450S (Americas) EF97S: XH4466-001 / 115D05E0018 (Europe) EF97SAP: 115D05E7018 (other areas)
*	Embroidery frame set H 20 cm × W 20 cm (H 8 inches × W 8 inches)
	SA446 (U.S.A.) / SA446C (Canada) EF91: XG6715-001 (Europe) EF91: XE5068-101 (other areas)
*	Embroidery frame set H 15 cm × W 15 cm (H 6 inches × W 6 inches)
	SA448 (U.S.A.) / SA448C (Canada) SEF150: XG6761-001 (Europe) SFE150: 115D05E700E (other areas)
*	Embroidery frame set H 2 cm × W 6 cm (H 1 inch × W 2-1/2 inches)
	SA437 (Americas) EF73: XG6663-001 (Europe) EF73CN: 115D05E600W (China) EF73: 115D05E700W (other areas)
*	Border embroidery frame H 30 cm × W 10 cm (H 12 inches × W 4 inches)
	SABF6200D1 (U.S.A.) / SABF6200D1C (Canada) BF3: XG6763-001 (Europe) BF3: XF4170-001/115D05E700N (other areas)
	Embroidery foot "W"
	XF4012-001
	Multi-purpose screwdriver
	SAMDRIVER1 (U.S.A.) / SAMDRIVER1C (Canada) MDRIVER1: XG1298-001 / 115Z05E0003 (Europe) MDRIVER1AP: 115Z05E7003 (other areas)

	Part Name
	Part Code
	10 spool stand
	SA561 (U.S.A.) / SA561C (Canada) TS5: XG6765-001 (Europe) TS5: 115L05E7003 (other areas)
	Spool stand
	SA562 (U.S.A.) / SA562C (Canada) TS6: XF4180-001 (Europe) TS6: 115L05E7002 (other areas)
	Stabilizer material
	SA519 (Americas) BM3: XG6683-001 / 115Z05E0007 (Europe) BM3CN: 115Z05E6007 (China) BM3: XE0806-001 (other areas)
	Water soluble stabilizer
	SA520 (Americas) BM5: XG6681-001 (Europe) BM5CN: 115Z05E600J (China) BM5: XE0615-001 (other areas)
	USB mouse
	XE5334-101

Memo

- To obtain optional accessories or parts, contact your authorized Brother dealer or visit our site "<http://s.brother/cpeab/>".
- All specifications are correct at the time of printing. Please be aware that some specifications may change without notice.
- Visit your nearest authorized Brother dealer or our site "<http://s.brother/cpeab/>" for a complete listing of optional accessories available for your machine.
- Always use accessories recommended for this machine.

TURNING THE MACHINE ON/OFF

⚠ WARNING

- Use only regular household electricity for the power source. Using other power sources may result in fire, electric shock, or damage to the machine.
- Make sure that the plugs on the power cord are firmly inserted into the electrical outlet and the power cord receptacle on the machine. Otherwise, a fire or electric shock may result.
- Do not insert the plug on the power cord into an electrical outlet that is in poor condition.
- Turn the main power to OFF and remove the plug in the following circumstances:
 - When you are away from the machine
 - After using the machine
 - When the power fails during use
 - When the machine does not operate correctly due to a bad connection or a disconnection
 - During electrical storms

⚠ CAUTION

- Use only the power cord included with this machine.
- Do not use extension cords or multi-plug adapters with many other appliances plugged in to them. Fire or electric shock may result.
- Do not touch the plug with wet hands. Electric shock may result.
- When unplugging the machine, always turn the main power to OFF first. Always grasp the plug to remove it from the outlet. Pulling on the cord may damage the cord, or lead to fire or electric shock.
- Do not allow the power cord to be cut, damaged, modified, forcefully bent, pulled, twisted, or bundled. Do not place heavy objects on the cord. Do not subject the cord to heat. These things may damage the cord, or cause fire or electric shock. If the cord or plug is damaged, take the machine to your authorized Brother dealer for repairs before continuing use.
- Unplug the power cord if the machine is not to be used for a long period of time. Otherwise, a fire may result.

- (For U.S.A only)
This appliance has a polarized plug (one blade wider than the other). To reduce the risk of electrical shock, this plug is intended to fit in a polarized electrical outlet only one way. If the plug does not fit fully in the electrical outlet, reverse the plug. If it still does not fit, contact a qualified electrician to install the proper electrical outlet. Do not modify the plug in any way.

- 1 Insert the power supply cord into the power cord receptacle, then insert the plug into a wall outlet.

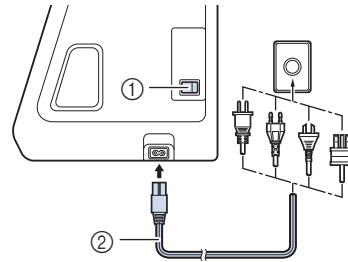

- ① Main power switch
- ② Power supply cord

- 2 Turn the main power switch to "I" to turn on the machine.

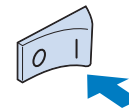

📖 Memo

- The light, LCD and the "Start/Stop" button light up when the machine is turned on. The machine will make a sound. This is not a malfunction.

- 3 When the machine is turned on, the opening movie is played. Press anywhere on the screen.

- 4 Turn the main power switch to "O" to turn off the machine.

■ Setting Your Machine for the First Time

When you first turn on the machine, set the language and time/date to your language and local time/date.

- 1 Press and to set your local language and then press .

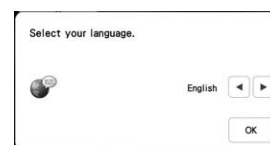

2 The message screen, confirming if you want to set time/date, appears. Press **OK**.

3 Press **-** or **+** to set time/date.

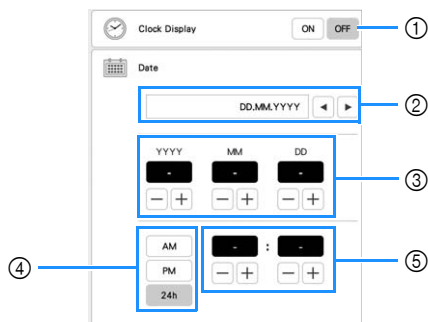

- ① Select [ON] to display time/date on the screen.
- ② Press **◀** or **▶** to select the date display format.
- ③ Set the year (YYYY), month (MM) and date (DD).
- ④ Select whether 24h or 12h setting will display.
- ⑤ Set the current time.

4 Press **OK** to set.

→ The clock starts from 0 second of the time you set.

Note

- The time/date you set may be cleared, if you don't turn on the machine for an extended period of time.

LCD SCREEN

Touch the LCD screen or a key with your finger or the included touch pen to select a machine function.

⚠ CAUTION



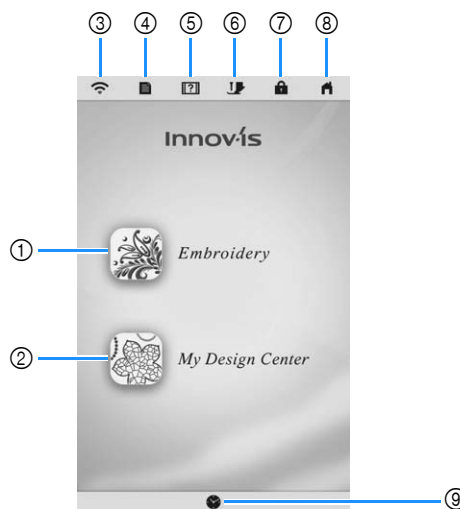

- Only touch the screen with your finger or the touch pen (stylus) included with the machine. Do not use a mechanical pencil, screwdriver or any other hard or sharp object. In addition, do not press the screen with extreme pressure. Otherwise the screen may be damaged.
- All or part of the screen may sometimes become darker or lighter due to changes in the surrounding temperature or other changes in the environment. This is not a sign of a malfunction. If the screen is difficult to read, adjust its brightness.

■ Home Page Screen



No.	Display Name	Explanation	Page
①	Embroidery key	Select an embroidery pattern.	34
②	My Design Center key	Create an original embroidery pattern.	86
③	Wireless LAN key	Shows the machine's signal strength. Press this key to specify the wireless settings.	17, 20
④	Machine settings key	Change the needle stop position, adjust the pattern or screen, and change other machine settings.	16
⑤	Machine help key	See explanations on how to use the machine. You can see the tutorial videos and also MP4 movie files that you have saved on USB media.	19
⑥	Presser foot/Needle exchange key	Press this key before changing the needle, the presser foot, etc. This key locks all key and button functions to prevent operation of the machine. Press this key again to unlock the settings.	26, 30
⑦	Screen lock key	Lock the screen. When the screen is locked, can still embroider, but cannot change any of the screen functions. Press this key again to unlock the screen.	—
⑧	Home page screen key	Return to the home page screen at any time and select a different mode ([Embroidery] or [My Design Center]).	—
⑨	Time/Date key	Set the time/date.	14



Using the Machine Settings Key

Press  to change the default machine settings (needle stop position, embroidery speed, opening display, etc.). To display the different settings screens, press  for “General settings”,  for “Embroidery settings” or  for “Wireless LAN settings”.

Note

- The machine default setting is highlighted.

Memo

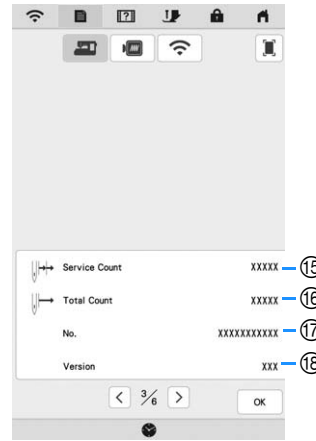
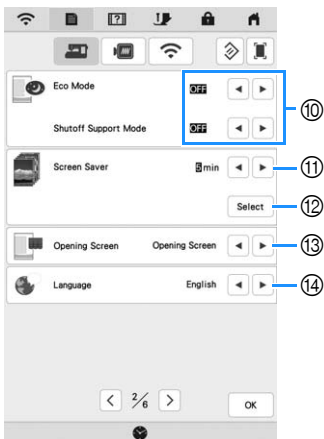
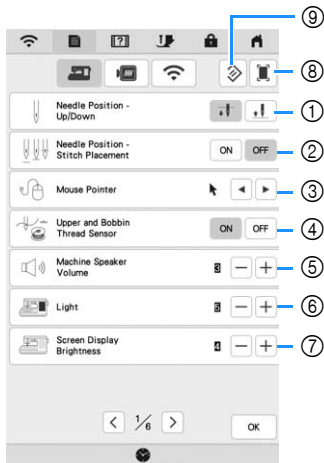

- Press  or  to display a different settings screen.

General Settings



CAUTION

- When [Upper and Bobbin Thread Sensor] is set to [OFF], the machine cannot detect tangled upper thread. Continuing to use the machine with tangled thread may cause damage.

- ① Select the needle stop position (the needle position when the machine is not operating) to be up or down.
- ② Select the operation of the  (Needle position button) from the following two sequences.
Each press of the  (Needle position button):
[ON] : Switches the needle position between being raised, stopped immediately before entering the fabric, or lowered.
[OFF] : Switches the needle position between being raised or lowered.
- ③ Select the shape of the pointer when a USB mouse is used.
- ④ Turn both the upper and bobbin thread sensors [ON] or [OFF]. If it is turned [OFF], the machine can be used without thread.
- ⑤ Select the speaker volume. Increase the number for louder volume, decrease for softer volume.
- ⑥ Select the brightness of the work area lights.
- ⑦ Select the screen display brightness.
- ⑧ You can save the current settings screen image in a USB media by pressing this button when the USB media is inserted into the USB port. The files are saved in a folder labeled [bPocket].
- ⑨ Reset settings on this page to original default. Some settings are not reset.
- ⑩ Set the [Eco Mode] and the [Shutoff Support Mode] to save the machine power (page 17).
- ⑪ Select the length of time until the screen saver appears.
- ⑫ Select the image of the screen saver (page 18).
- ⑬ Select the initial screen that is displayed when the machine is turned on.
- ⑭ Select the display language.
- ⑮ Shows the service count which is a reminder to take your machine in for regular servicing. (Contact your authorized Brother dealer for details.)
- ⑯ Shows the total number of stitches embroidered on this machine.
- ⑰ Shows the internal machine number for this machine.
- ⑱ Shows the program version.

Memo

- Install the latest software. Check with your local authorized Brother dealer or at “ <http://s.brother/cpeab/> ” for available updates (page 118).

Embroidery Settings

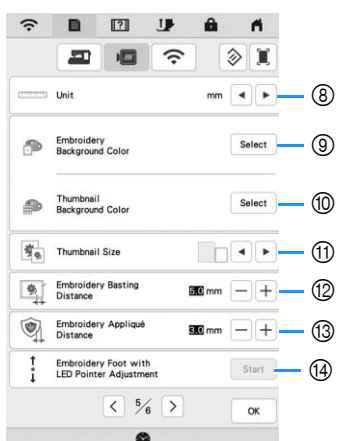
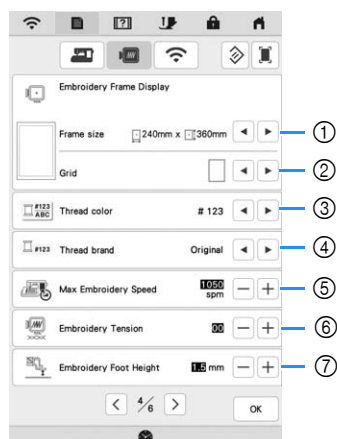

- ① Select the embroidery frame to be used.
- ② Select the center point marker or grid lines.
- ③ Select the thread color display on the embroidery screen; thread number, color name. (page 77)
- ④ Select the thread brand of the thread color display. (page 77)
- ⑤ Adjust the maximum embroidery speed (page 77).
- ⑥ Adjust the upper thread tension for embroidering (page 74).
- ⑦ Select the height of the embroidery foot during embroidering (page 55).
- ⑧ Select the display units for embroidering (mm/inch).
- ⑨ Select the color of the background for the embroidery display area.
- ⑩ Select the color of the background for the thumbnail area.
- ⑪ Select the size of pattern thumbnails.
- ⑫ Adjust the distance between the pattern and the basting stitching. (page 70)
- ⑬ Adjust the distance between the appliqué pattern and the outline (page 70).
- ⑭ Adjust the position and brightness of the embroidery foot "W+" with LED pointer (this setting is available if embroidery foot "W+" with LED pointer has been attached.) (page 59)

Wireless LAN Settings

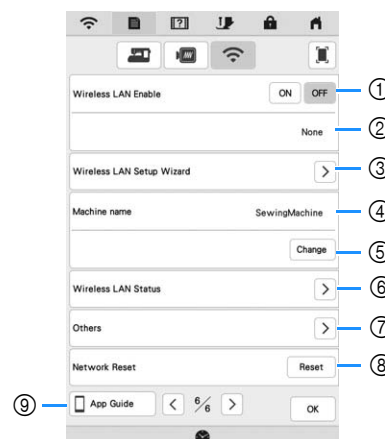

- ① Enable/Disable the wireless LAN function (page 20).
- ② Shows the connected SSID.
- ③ Set the machine to connect wireless LAN function.
- ④ Shows the machine name used on the wireless network. This name is used when transferring files from the machine to the embroidery editing software (PE-DESIGN 11).
- ⑤ Change the machine name used on the wireless network.
- ⑥ Check the wireless LAN status.
- ⑦ Display other menus.
- ⑧ Reset network operations.
- ⑨ Display the introduction to the application.

Setting the [Eco Mode] and the [Shutoff Support Mode]

You can save the machine power by setting the [Eco Mode] and the [Shutoff Support Mode].

If you leave the machine turned on without using it for the set period of time, the machine enters in each mode. Press  to display [Eco Mode] and [Shutoff Support Mode]. (page 16)

[Eco Mode];

Machine will enter a sleep mode after the set period of time. Touch the screen or press the "Start/Stop" button to continue operating.

[Shutoff Support Mode];



Machine will enter the lower power mode after the set period of time. Turn the machine off and then back on to restart operating.

Note

- If you turn off the machine while the machine is in the [Eco Mode] or the [Shutoff Support Mode], wait for about 5 seconds before turning on the machine again.

■ Changing the Screen Saver Image

Instead of the default image, you can select your own personal images for the screen saver of your machine. Before changing the screen saver image, prepare the image on USB media. For details on compatible image files, refer to "SPECIFICATIONS" on page 116.

- 1 Press  .
→ The settings screen appears.
- 2 Press  .
→ The general settings screen appears.
- 3 Display [Screen Saver] in the general settings screen.

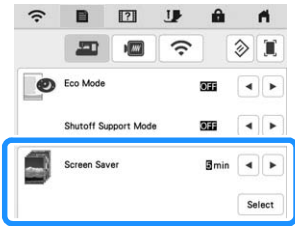

- 4 Press in [Screen Saver].

- 5 Press .

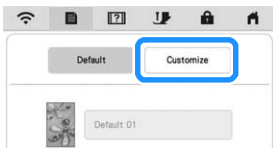

- 6 Connect the USB media that contains your personal image to the USB port of the machine.

- 7 Press to select the first image.



- 8 Select the device that is connected.

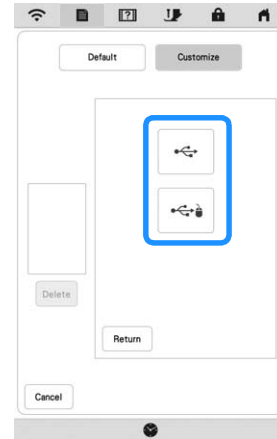

→ A list of your personal images appears on the screen.

- * : Delete the selected image.
- * : Return to the previous page.

- 9 Select a file name and then press .



→ The selected image is stored on your machine.

- * : Return to the previous page.

- 10 Repeat steps 7 through 9 to set the remaining images.

- 11 Press to return to the original screen.

Using the Machine Help

Press  to display the machine help screen. Functions are available from the screen shown below.

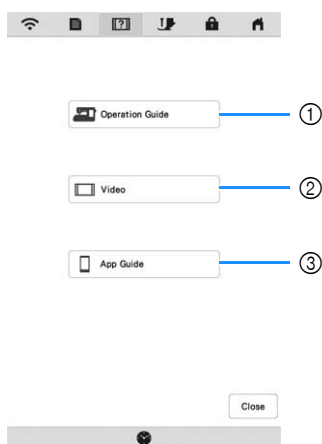

- ① Explanation for upper threading, winding the bobbin, preparing to embroider a pattern, and how to use the machine (page 19)
- ② Tutorial videos or MPEG-4 (MP4) videos (page 19, page 20)
- ③ Introduction to the application

Using the Operation Guide Function

Press  to display the screen shown below. Categories are displayed at the top of the screen. Press a key to see more information about that category. Some of the functions are described in the movies. Watch these movies for a better understanding of the functions.



- ① Information about the main parts of the machine and their functions
- ② Information about the operation buttons
- ③ Information about threading the machine, changing needles, etc.
- ④ Information about attaching the embroidery unit, preparing fabric for embroidering, etc.
- ⑤ Information about troubleshooting
- ⑥ Information about cleaning the machine, etc.

Playing a Tutorial Video

This machine provides tutorial videos on how to use the machine.

1 Press .

2 Press .

3 Select the category and the tutorial video.

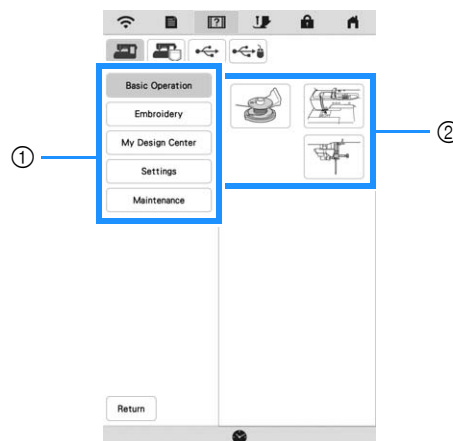

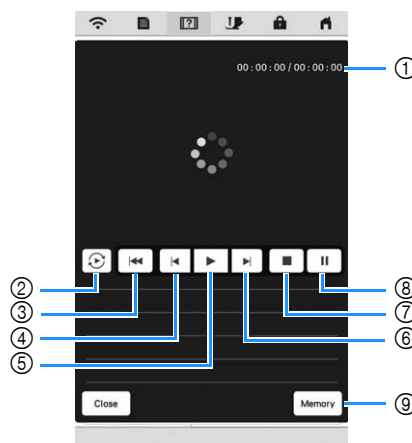

- ① Category
- ② Tutorial video

4 Play the tutorial video.



- ① Number of seconds elapsed/Total number of seconds
- ② Repeat
- ③ Return to beginning
- ④ Skip back 10 seconds
- ⑤ Play
- ⑥ Skip forward 10 seconds
- ⑦ Stop
- ⑧ Pause
- ⑨ Save to machine (when playing from USB media).

A video can be saved to  (favorites) of the machine, from where it can be played.

When playing from the machine's memory,  changes to . Press  to delete the video.

Note

- The specifications shown in the movie may differ from the ones on the actual product, in details.

5 After you are finished playing the video, press .

■ Playing MPEG-4 (MP4) Videos

Your MP4 videos can be played from USB media. In addition, the MP4 video can be saved to the machine so that a tutorial video on creating a project, for example, can be viewed at any time. For details on supported file extensions, refer to “SPECIFICATIONS” on page 116.

Memo

- Some type of MP4 file cannot be played with the machine.

1 Press .

2 Press .

3 Select the device where the video is saved.

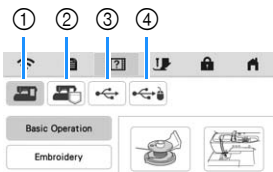

- 1 Tutorial videos
- 2 Videos saved on the machine (favorites)
- 3 Videos from USB media plugged into the USB port
- 4 Videos from USB media plugged into the USB port for mouse

4 Select the video that you want to play.

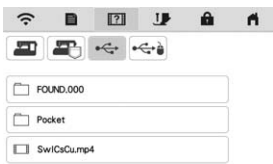

Note

- Long file names may be shortened when they are displayed.

5 Play the video.

* Use the operation keys as described in “Playing a Tutorial Video” on page 19.

6 After you are finished playing the video, press .

WIRELESS NETWORK CONNECTION FUNCTIONS

This machine supports a wireless network connection. Using this function, an embroidery pattern edited in embroidery editing software (PE-DESIGN 11) with wireless transfer functions can be transferred to the machine from a computer. Embroidery patterns can be transferred from the machine to the embroidery editing software. The machine and computer must be connected to the same network. For detailed procedures, refer to the manual for the embroidery editing software. The wireless network must be set up and enabled to use the special application to transfer images to the embroidery machine.

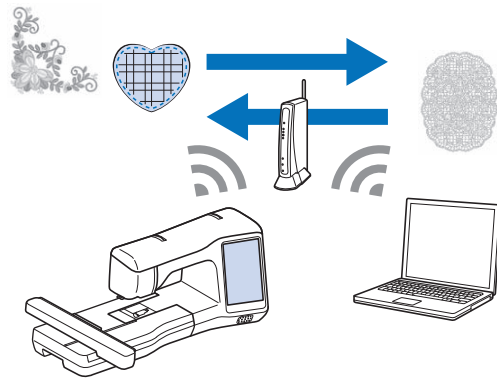

Enabling a Wireless Network Connection

The machine can be connected to your wireless network.

1 Press .

2 Press .

3 Set [Wireless LAN Enable] to [ON].

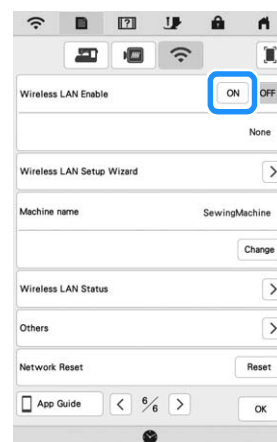

→ The machine begins to emit the wireless network signal.

■ Requirements for a Wireless Network Connection

The wireless network connection complies with IEEE 802.11 n/g/b standards and uses the 2.4 GHz frequency.

📝 Memo

- A wireless network cannot be set up with WPA/WPA2 Enterprise.

Setting Up the Wireless Network Connection

There are multiple ways to set up the wireless network connection. We recommend the method that uses the wizard on this machine.

■ Using the Wizard to Set Up the Wireless Network Connection

- 1 In order to connect your machine to a wireless network, the security information (SSID and network key) for your home network will be required. The network key may also be called a password, security key or encryption key. First, find your security information and note it.

SSID	Network Key (Password)

📝 Memo

- The wireless network connection cannot be set up if you do not have the security information.
- How to find the security information
 - ① Check the manual provided with your home network.
 - ② The default SSID may be the manufacturer's name or the model name.
 - ③ If you cannot find the security information, contact the manufacturer of the router, your network administrator or your Internet provider.

- 2 Press **>** beside [Wireless LAN Setup Wizard].

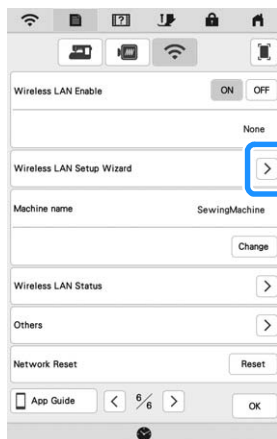

→ A list of available SSIDs appears.

- 3 Press **>** beside the SSID that was noted.

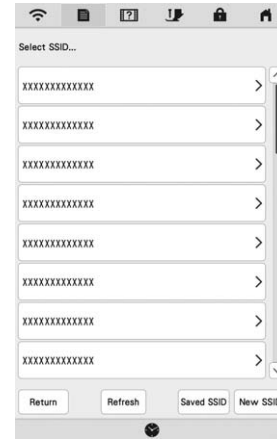

→ The screen for entering the network key (password) appears.

📝 Memo

- If the SSID that was noted does not appear in the list, press **Refresh**.
- If the SSID that was noted is not displayed, specify it as described below.
 - ① Select **New SSID** in the list of SSIDs.
 - ② Enter the desired network SSID, and then press **OK**.
 - ③ Select the authentication method and encryption mode.
- If the machine had already been connected to the home network, press **Saved SSID**, and then select the saved SSID.

- 4 Enter the network key (password) that was noted, and then press **OK**.

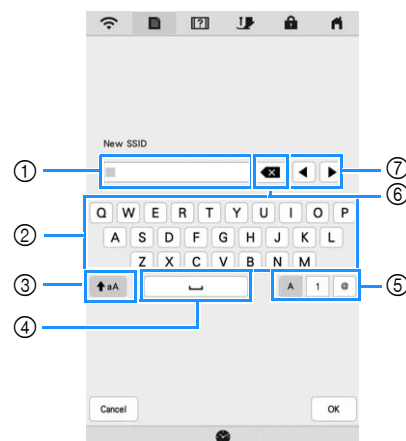

- ① Text input area
- ② Character keys
- ③ Caps key
- ④ Space key
- ⑤ Letters/numbers/symbols key
- ⑥ Backspace key (Deletes the character at the cursor's position.)
- ⑦ Cursor keys (Move the cursor to the left or right.)

5 When the following message appears, press .

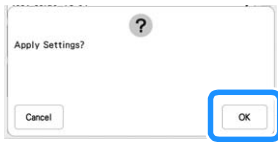

→ When a connection is established, the following message appears.

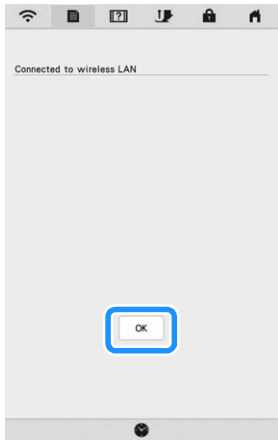

6 Press to exit the setup.



Memo

- While connected, the signal strength is indicated by the icon in the upper-left corner of the display.
- Once a wireless network connection has been set up, a connection will be established each time the machine is turned on. However, [Wireless LAN Enable] in the network settings screen must remain set to [ON].

■ Using the [Others] Menu to Set Up the Wireless Network Connection

The [Others] menu contains the following items.

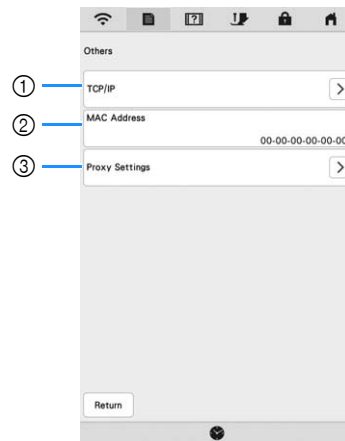

- ① TCP/IP settings can be manually entered.
- ② Shows the MAC address.
- ③ Use when proxy settings are required.

CONNECTING THE ACCESSORY TO THE MACHINE

Using a USB Mouse (Sold Separately)

The USB mouse, connected to the machine, can be used to perform a variety of operations in the screens. Connect a USB mouse to the USB port.

Memo

- If a mouse other than the optional USB mouse is used, it may not perform as described in this Operation Manual.

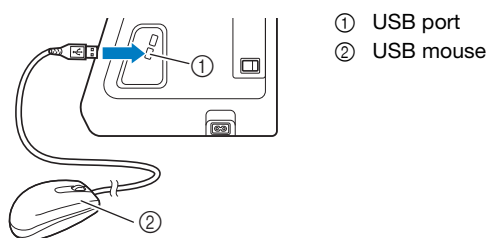

Note

- Only the left mouse button can be used to perform operations. Double-clicking has no effect. No other buttons can be used.
- The mouse pointer does not appear in the screen saver or opening screen.

Clicking a Key

When the mouse is connected, the pointer appears on the screen. Move the mouse to position the pointer over the desired key, and then click the left mouse button.



① Pointer

WINDING/INSTALLING THE BOBBIN

Winding the Bobbin

CAUTION

- The included bobbin was designed specifically for this machine. If bobbins from other models are used, the machine will not operate correctly. Use only the included bobbin or bobbins of the same type (part code: SA156, SFB: XA5539-151 / 115J05E0001, SFB: 115J05E7001). SA156 is Class 15 type bobbin.

Using the Supplemental Spool Pin

With this machine, you can wind the bobbin during embroidering. While using the main spool pin for embroidery, you can conveniently wind the bobbin using the supplemental spool pin.

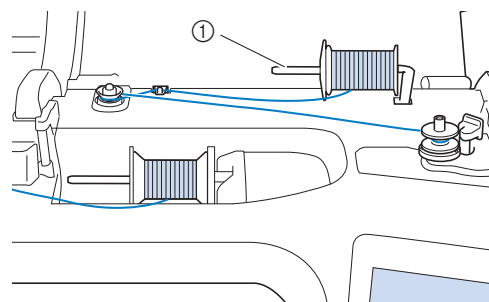

① Supplemental spool pin

- 1 Turn the main power to ON and open the top cover.

- 2 Align the groove in the bobbin with the spring on the bobbin winder shaft, and set the bobbin on the shaft.

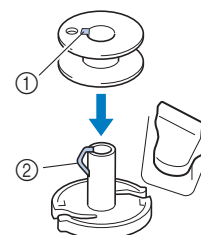

- ① Groove in the bobbin
- ② Spring on the bobbin winder shaft

- 3 Place the spool of thread for the bobbin and the spool cap onto the supplemental spool pin.

Slide the spool onto the supplemental spool pin so that the thread unwinds to the front from the bottom.

Otherwise the thread may become tangled around the supplemental spool pin.

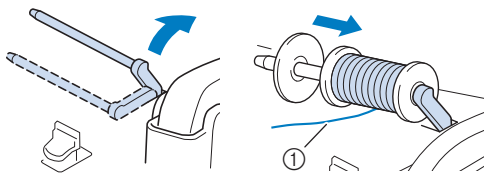

① The thread unwinds to the front from the bottom.

- 4 Slide the spool cap onto the spool pin as far as possible to the right, with the rounded side on the left.

⚠ CAUTION

- If the spool or the spool cap is not installed correctly, the thread may become tangled around the spool pin, causing the needle to break.
- Three spool cap sizes are available, allowing you to choose a spool cap that best fits the size of spool being used. If the spool cap is too small for the spool being used, the thread may catch on the slit in the spool or the machine may be damaged. When using mini king thread spool, use the thread spool insert (mini king thread spool). For details on thread spool insert (mini king thread spool), refer to “Memo” on page 24.



📄 Memo

- When using the spool as shown below, use the small spool cap, and leave a small space between the cap and the spool.

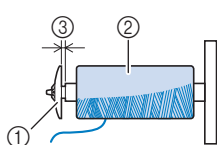

- ① Spool cap (small)
- ② Spool (cross-wound thread)
- ③ Space

- If a spool of thread whose core is 1.2 cm (approx. 1/2 inch) in diameter and 7.5 cm (approx. 3 inches) high is inserted onto the spool pin, use the thread spool insert (mini king thread spool).

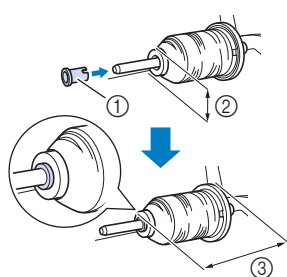

- ① Thread spool insert (mini king thread spool)
- ② 1.2 cm (approx. 1/2 inch)
- ③ 7.5 cm (approx. 3 inches)

- 5 With your right hand, hold the thread near the thread spool. With your left hand, hold the end of the thread, and use both hands to pass the thread through the thread guide.

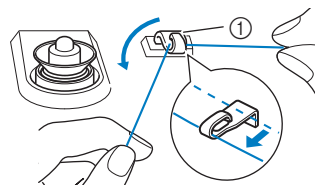

① Thread guide

- 6 Pass the thread around the pretension disk making sure that the thread is under the pretension disk.

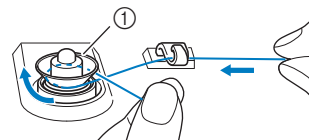

① Pretension disk

→ Make sure that the thread passes under the pretension disk.

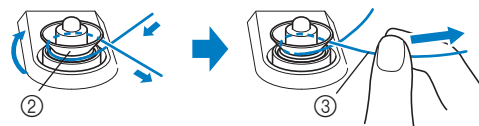

② Pretension disk

③ Pull it in as far as possible.

- 7 Wind the thread clockwise around the bobbin 5 or 6 times, pass the thread through the guide slit in the bobbin winder seat, and then pull the thread to cut it.

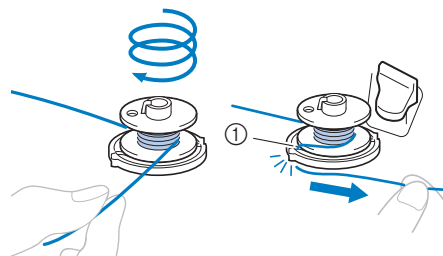

① Guide slit in bobbin winder seat (with built-in cutter)

💡 Note

- Be sure to wind the thread clockwise around the bobbin, otherwise the thread may become wrapped around the bobbin winder shaft.

⚠ CAUTION

- Be sure to cut the thread as described. If the bobbin is wound without cutting the thread using the cutter built into the guide slit in the bobbin winder seat, the thread may become tangled in the bobbin or the needle may bend or break when the bobbin thread starts to run out.

- 8 Set the bobbin winding switch to the left, until it clicks into place.

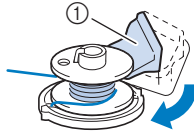

- ① Bobbin winding switch
→ The bobbin winding window appears.

- 9 Press **Start**.



→ Bobbin winding starts. The bobbin stops rotating when bobbin winding is completed. The bobbin winding switch will automatically return to its original position.

→ **Start** changes to **Stop** while the bobbin is winding.

→ You can change the winding speed by pressing **-** (to decrease) or **+** (to increase) in the bobbin winding window.

Note

- The sound of winding the bobbin with stiff thread, such as metallic thread for quilting, may be different from the one produced when winding normal thread; however, this is not a sign of a malfunction.

Memo

- Press **OK** to minimize the bobbin winding window. Then, you can perform other operations, such as selecting a pattern or adjusting the thread tension, while the bobbin is being wound.
- Press  (in top right of the LCD screen) to display the bobbin winding window again.



- 10 After bobbin winding is finished, cut the thread with scissors and remove the bobbin.

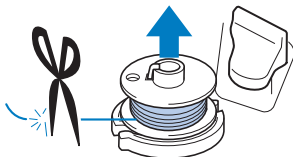

Using the Spool Pin

You can use the main spool pin to wind the bobbin before embroidering. You cannot use this spool pin to wind the bobbin while embroidering.

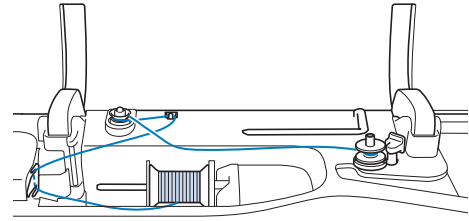

- 1 Turn the main power to ON and open the top cover.

- 2 Align the groove in the bobbin with the spring on the bobbin winder shaft, and set the bobbin on the shaft.

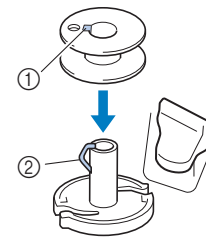

- ① Groove in the bobbin
② Spring on the bobbin winder shaft

- 3 Remove the spool cap and place the spool of thread for the bobbin onto the spool pin.

Slide the spool onto the spool pin so that the thread unwinds to the front from the bottom.

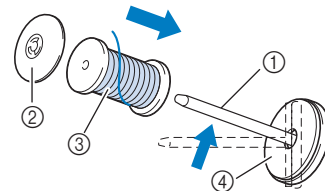

- ① Spool pin
② Spool cap
③ Spool of thread
④ Spool felt

- 4 Slide the spool cap onto the spool pin as far as possible to the right, with the rounded side on the left.

- 5 While holding the thread with both hands, pass the thread through grooves of the thread guide plate.

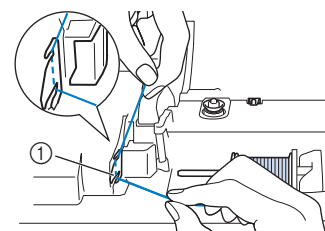

- ① Thread guide plate

6 Pass the thread through the thread guide.

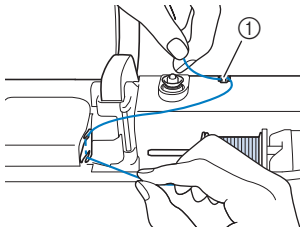

① Thread guide

7 Pass the thread around the pretension disk making sure that the thread is under the pretension disk.

Pull the thread as far as possible.

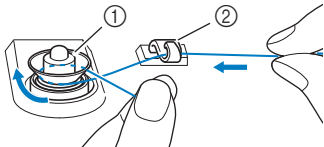

① Pretension disk
② Thread guide

8 Follow steps **7** through **10** on page 24 through page 25.

Setting the Bobbin

⚠ CAUTION

- Use a bobbin that has been correctly wound with thread, otherwise the needle may break or the thread tension will be incorrect.



- Before inserting or changing the bobbin, be sure to press  in the LCD to lock all keys and buttons. Otherwise injuries may occur if the “Start/Stop” button or any other button is pressed and the machine starts embroidering.

1 Press  to lock all keys and buttons and raise the presser foot.

- * If the message [OK to automatically lower the presser foot?] appears on the LCD screen, press

 to continue.

2 Slide the bobbin cover latch to the right and remove the bobbin cover.

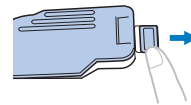

3 Insert the bobbin into the bobbin case so that the thread unwinds to the left.

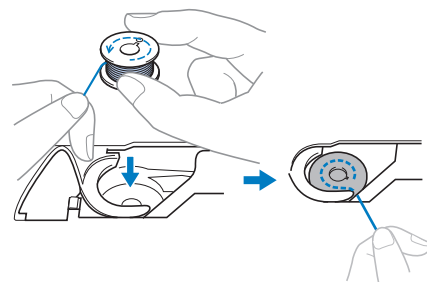

- 4 Lightly hold down the bobbin with your right hand (①), and then guide the end of the thread around the tab of the needle plate cover with your left hand (②).

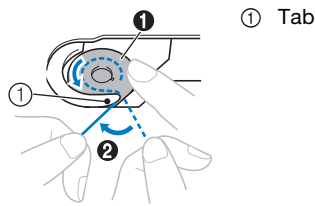

⚠ CAUTION

- Be sure to hold down the bobbin with your finger and unwind the bobbin thread correctly, otherwise the thread may break or the thread tension will be incorrect.

- 5 While lightly holding down the bobbin with your right hand (①), guide the thread through the slit in the needle plate cover (②) and lightly pull it with your left hand (③).

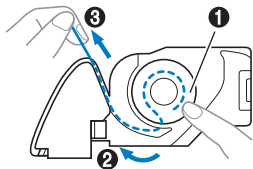

📖 Memo

- By guiding the thread around the tab of the needle plate cover, passing the thread as shown by ② in this illustration, then lightly pulling the thread at ③, the thread will enter the tension spring of the bobbin case to apply the appropriate tension to the bobbin thread during embroidering.

- 6 While lightly holding down the bobbin with your right hand (①), continue guiding the thread through the slit with your left hand (②). Then, cut the thread with the cutter (③).

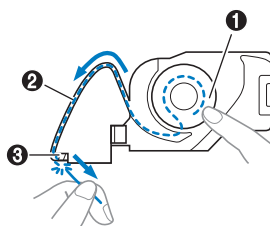

📖 Memo

- Be sure to complete the bobbin threading correctly according to these instructions. If the thread is simply placed in the slit in the needle plate cover, the bobbin thread will not be correctly threaded, resulting in poor embroidering performance or incorrect thread tension.

- 7 Reattach the bobbin cover.

Insert the tab of the bobbin cover into the notch of the needle plate cover, and then lightly press down on the right side.

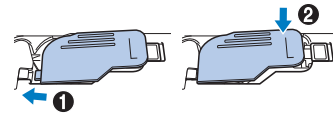

- 8 Press  to unlock all keys and buttons.

UPPER THREADING

Upper Threading

⚠ CAUTION

- Be sure to thread the machine properly. Improper threading can cause the thread to tangle and break the needle, leading to injury.

📖 Memo

- The automatic threading function can be used with home sewing machine needle size 75/11.
- The following threads are incompatible with the needle threader. Manually pass the thread through the eye of the needle.
 - Speciality threads such as metallic threads

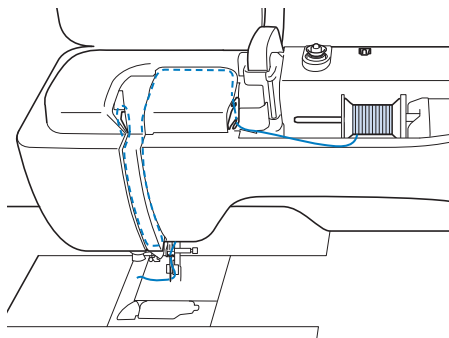

1 Turn the main power to ON.

2 Press  (Presser foot lifter button) to raise the presser foot.

→ The upper thread shutter opens so the machine can be threaded.

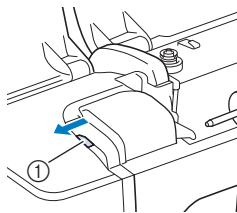

① Upper thread shutter

3 Press  (Needle position button) to raise the needle.

💡 Note

- If you try to thread the needle automatically without raising the needle, the needle may not be thread correctly and the needle threader may be damaged.

4 Remove the spool cap and place the spool of thread onto the spool pin.

Slide the spool onto the spool pin so that the thread unwinds to the front from the bottom.

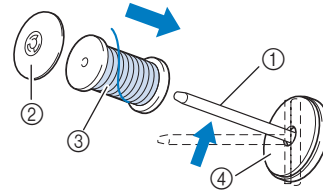

- ① Spool pin
- ② Spool cap
- ③ Spool of thread
- ④ Spool felt

5 Slide the spool cap onto the spool pin as far as possible to the right, with the rounded side on the left.

⚠ CAUTION

- Choose a spool cap that best fits the size of spool being used. For more information, refer to "Memo" on page 24.

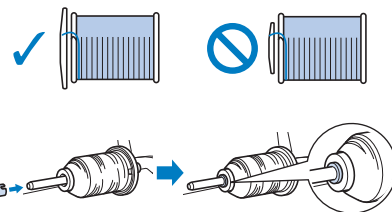

- If the spool or the spool cap is not positioned correctly, the thread may become tangled around the spool pin or the needle may break.

📖 Memo

- When using thread that winds off quickly, such as metallic thread, place the spool net over the spool before placing the spool of thread onto the spool pin. If the spool net is too long, fold it to fit the size of the spool. When threading the spool with the spool net on, make sure that about 5 cm (2 inches) of thread is pulled out. It may be necessary to adjust the thread tension when using the spool net.

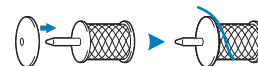

6 While holding the thread with both hands, pass the thread through grooves of the thread guide plate.

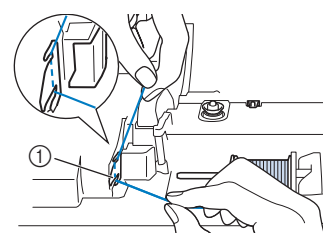

① Thread guide plate

- 7** While holding the thread in your right hand, pass the thread through the thread guide in the direction indicated.

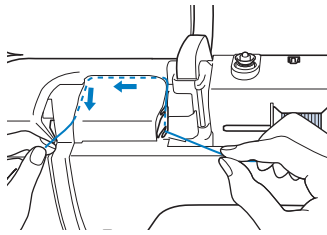

- 8** Guide the thread down, up, then down through the groove, as shown in the illustration.

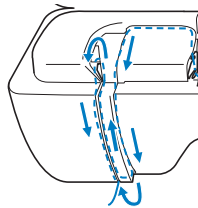

Memo

- Look in the upper groove area to check if the thread catches on the thread take-up lever visible inside the upper groove area.

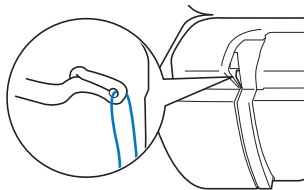

- 9** Pass the thread through the needle bar thread guide (marked "6") by holding the thread with both hands and guiding it as shown in the illustration.

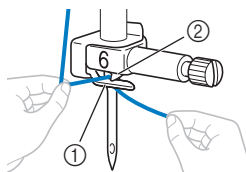

- ① Needle bar thread guide
- ② Tab

- 10** Pass the thread through the notch in the thread guide. Then firmly pull the thread from front to back into the slit of the thread guide disk (marked "7").

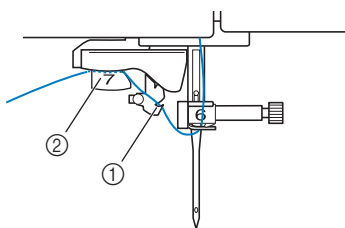

- ① Notch in thread guide
- ② Thread guide disk

- 11** Press  (Presser foot lifter button) to lower presser foot.

- 12** Pull the thread up through the thread cutter to cut the thread, as shown in the illustration.

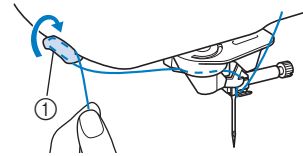

- ① Thread cutter

Note

- When using thread that quickly winds off the spool, it may be difficult to thread the needle if the thread is cut. Therefore, instead of using the thread cutter, pull out about 8 cm (3 inches) of thread after passing it through the thread guide disks (marked "7").

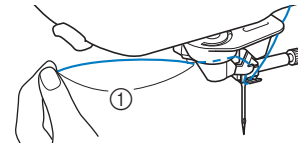



- ① About 8 cm (3 inches) or more

- 13** Press  (Automatic threading button) to have the machine automatically thread the needle.

→ The thread passes through the eye of the needle.

Memo

- When  (Automatic threading button) is pressed, the presser foot will be automatically lowered. After threading is finished, the presser foot moves back to the position before  (Automatic threading button) was pressed.

Note

- Some needles and threads cannot be threaded with the needle threader. In this case, instead of using the needle threader after passing the thread through the needle bar thread guide (marked "6"), manually pass the thread through the eye of the needle from the front.

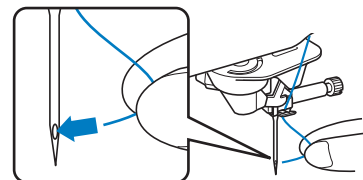

14 Carefully pull the end of the thread that was passed through the eye of the needle.

* If a loop was formed in the thread passed through the eye of the needle, carefully pull on the loop of thread through to the back of the needle.

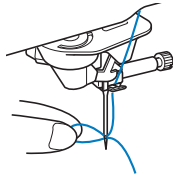

15 Raise the presser foot lever and pull out about 10 cm (4 inches) of the thread, and then pass it under the presser foot toward the rear of the machine.

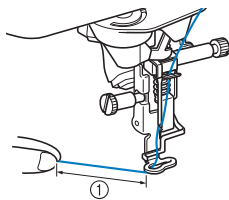

① About 10 cm (4 inches)

Memo

- If the needle could not be threaded or the thread was not passed through the needle bar thread guides, perform the procedure again starting from step 3.
- Then, pass the thread through the eye of the needle after step 9.

Using the Vertical Spool Pin

Use the vertical spool pin when using an irregularly shaped thread spool, and when embroidering with metallic thread.

1 Insert the vertical spool pin onto the bobbin winder shaft.

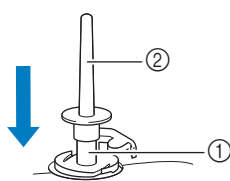

① Bobbin winder shaft
② Vertical spool pin

2 Install the spool felt and the thread spool in that order, and then thread the upper thread.

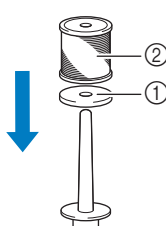



① Spool felt
② Thread spool

Memo

- When setting the thread spool, set it so that the thread winds off from the front of the spool.
- This method keeps the thread from twisting as it comes off the spool pin.

CHANGING THE NEEDLE

CAUTION

- Always press  on the screen to lock all keys and buttons before changing the needle. If  is not pressed and the "Start/Stop" button or another operation button is pressed accidentally, the machine will start and injury may result.
- Use only home sewing machine needles. Other needles may bend or break and may cause injury.
- Never use a bent needle. A bent needle will easily break and may cause injury.

Thread and Needle Number

The lower the thread number is, the heavier the thread; the higher the needle number, the larger the needle.

Embroidery Needles

Use a ball point needle 75/11.

Memo

- To check the needle correctly, place the flat side of the needle on a flat surface. Check the needle from the top and the sides. Throw away any bent needles.

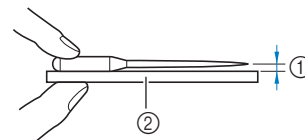

① Parallel space
② Flat surface (bobbin cover, glass, etc.)

1 Press  (Needle position button) to raise the needle.

2 Press  to lock all keys and buttons.

* If the message [OK to automatically lower the presser foot?] appears on the LCD screen, press  to continue.

Note

- Before replacing the needle, cover the hole in the needle plate with fabric or paper to prevent the needle from falling into the machine.

3 Remove the presser foot. (page 107)

- 4 Use the disc-shaped screwdriver to turn the needle clamp screw toward you (counterclockwise) to loosen the screw. Remove the needle.

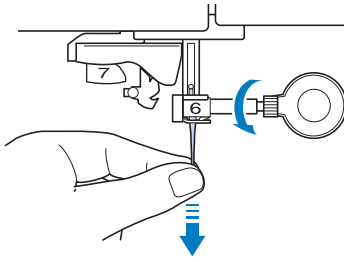

- 5 With the flat side of the needle facing the back, insert the new needle all the way to the top of the needle stopper (viewing window) in the needle clamp. Use the disc-shaped screwdriver to securely tighten the needle clamp screw.

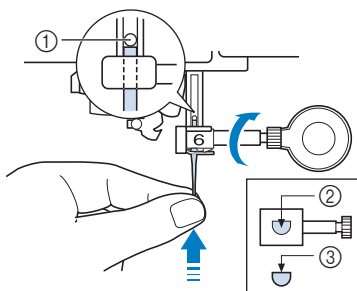

- ① Needle stopper
 ② Hole for inserting the needle
 ③ Flat side of the needle

⚠ CAUTION

- Be sure to push in the needle until it touches the stopper, and securely tighten the needle clamp screw with the disc-shaped screwdriver. If the needle is not completely inserted or the needle clamp screw is loose, the needle may break or the machine may be damaged.

- 6 Attach the presser foot. (page 107)
- 7 Press  to unlock all keys and buttons.



Chapter **2**
Basic Embroidery



BEFORE EMBROIDERING

Embroidery Step by Step

Follow the steps below to prepare the machine for embroidery.

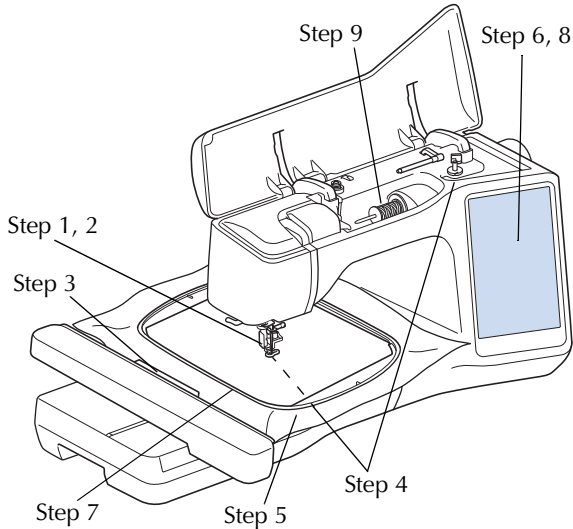

Step #	Aim	Action	Page
1	Presser foot attachment	Attach embroidery foot "W+" with LED pointer.	107
2	Checking the needle	Use needle 75/11 for embroidery.	30
3	Embroidery unit attachment	Attach the embroidery unit.	34
4	Bobbin thread setup	For the bobbin thread, wind embroidery bobbin thread and set it in place.	23
5	Fabric preparation	Attach a stabilizer material to the fabric, and hoop it in the embroidery frame.	55
6	Pattern selection	Turn the main power to ON, and select an embroidery pattern.	36
7	Embroidery frame attachment	Attach the embroidery frame to the embroidery unit.	58
8	Checking the layout	Check and adjust the size and position of the embroidery.	59
9	Embroidery upper thread setup	Set up embroidery upper thread according to the pattern.	28

About the Embroidery Unit

⚠ CAUTION

- Before attaching or removing the embroidery unit, be sure to turn off the machine. Otherwise, injuries may occur if one of the operation buttons is accidentally pressed.
- Do not move the machine with the embroidery unit attached. The embroidery unit could fall off and cause injury.
- Keep your hands and foreign objects away from the embroidery carriage and frame when the machine is embroidering. Otherwise, injuries or damage may result.
- To avoid distorting your embroidery design, do not touch the embroidery carriage and frame when the machine is embroidering.
- Do not push on the carriage when installing the embroidery unit onto the machine. Moving the carriage may damage the embroidery unit.
- Allow sufficient space around the embroidery unit. Otherwise, the embroidery unit could fall off foreign object, and may cause injury.
- Do not touch the embroidery carriage until the initialization finishes.
- Be sure to turn off the power before attaching or removing the embroidery unit. Otherwise, the machine may be damaged.
- Do not touch the inner connector of the embroidery unit. The pins on the embroidery unit connection may be damaged.
- Do not apply strong force to the embroidery unit carriage or pick up the unit by the carriage. Otherwise, the embroidery unit may be damaged.
- Store the embroidery unit in a safe place to prevent damage to the unit.
- Do not carry the embroidery unit by holding the carriage or release lever compartment.

■ Attaching the Embroidery Unit

- 1 Turn the main power to OFF.
- 2 Insert the embroidery unit connection into the machine connection port. Push lightly on the connection port cover until the unit clicks into place.

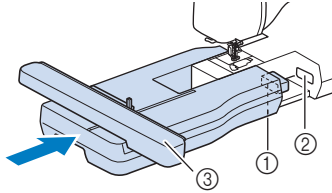

- ① Embroidery unit connection
- ② Machine connection port
- ③ Carriage

Note

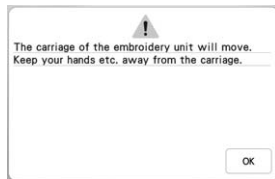

- Be sure there is no gap between the embroidery unit and the machine. If there is a gap, the embroidery patterns will not embroider with the correct registration.

- 3 Turn the main power to ON.
→ The following message will appear.



- 4 Press .
→ The carriage will move to the initialization position.

■ Removing the Embroidery Unit

- 1 Press , then press  .
→ The carriage will move to the removal position.

⚠ CAUTION

- Always remove the embroidery frame before pressing  . Otherwise, the frame may strike the embroidery foot, and possibly cause injury.

- 2 Turn the main power to OFF.
- 3 Squeeze the release lever, and pull the embroidery unit away from the machine.

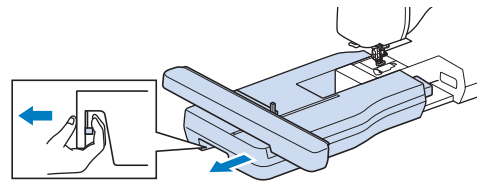

SELECTING PATTERNS

■ Copyright Information

The patterns stored in the machine and patterns sold separately are intended for private use only. Any public or commercial use of copyrighted patterns is an infringement of copyright law and is strictly prohibited.

■ About Embroidery Patterns

There are many character and decorative embroidery patterns stored in the machine's memory (see the "Quick Reference Guide" for a full summary of patterns in the machine's memory or visit "<http://s.brother.com/ea/>"). You can also use patterns sold separately.

Once the machine has finished the initialization and the carriage has moved to the start position, the pattern selection screen appears.

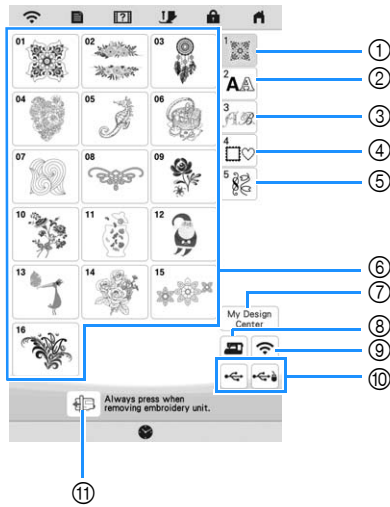

- ① Embroidery patterns
- ② Character patterns
- ③ Decorative alphabet patterns
- ④ Frame patterns
- ⑤ Utility embroidery patterns
- ⑥ Pattern type selection keys
- ⑦ My Design Center (page 86)
- ⑧ Patterns saved in the machine's memory (page 80)
- ⑨ Patterns to be transferred via the wireless network (page 80)
- ⑩ Patterns saved in USB media (page 80)
- ⑪ Move the embroidery unit carriage to the storage position.

Selecting Embroidery Patterns

- 1 Press the category tab and then press the pattern type selection key or pattern key you want to embroider.

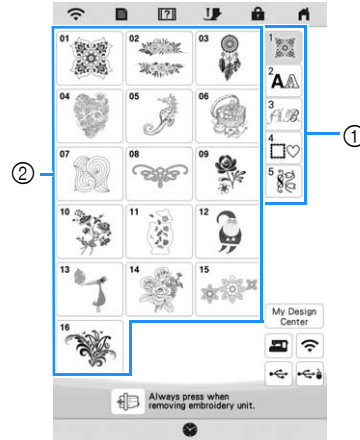

- ① Pattern category tab
- ② Pattern type/pattern selection key

- 2 Select a pattern.

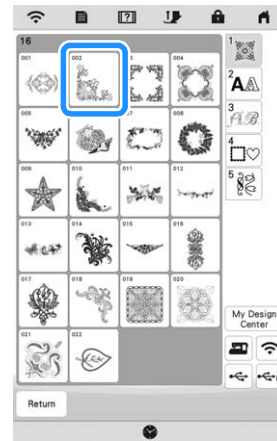

- * Press the category tab or Return to return to the previous screen.
- The selected pattern is displayed.

- 3 Press **Set** to set the pattern.

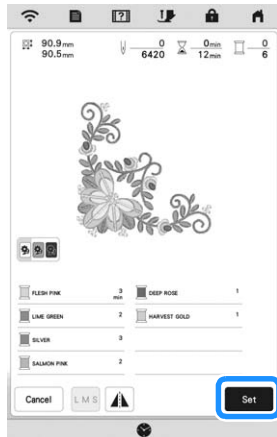

- * Press  to darken the background color for the pattern image with bright thread colors, to get a clearer image.

→ The pattern is designated with a red box around it on the edit screen.

- 4 Press **Edit** to edit the selected pattern. (page 42)



- 5 Press **Embroidery**.

→ The embroidery screen appears.

- 6 Press **Layout** to edit the pattern before embroidering. (page 53)

- * To return to the edit screen, press **Return**.

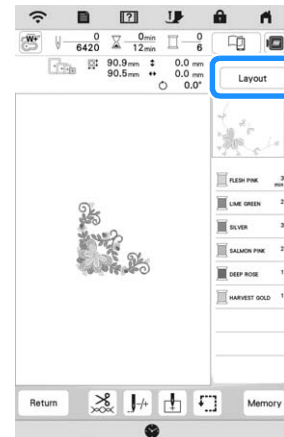

- 7 Start embroidering. (page 63)

Selecting Character Patterns

1 Press **A A**.

2 Press the key of the font you want to embroider.

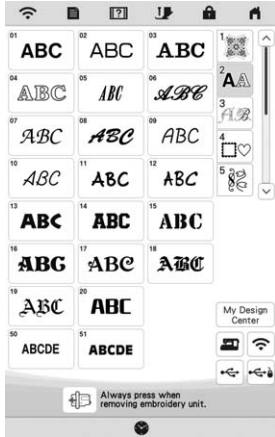

- * : View the next page.
- : View the previous page.

3 Select the character category and then type in the text. (page 38)



4 Press **Set**.

→ The edit screen appears.

5 Follow the steps from 4 to 7 of “Selecting Embroidery Patterns” on page 36.

Character Pattern Input Keys

Memo

- If a key display is grayed out, you cannot use that function with the selected pattern.

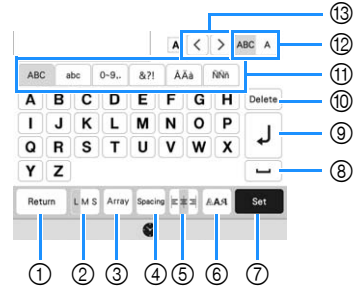

No.	Display	Explanation
	Name	
①		Return to the previous screen.
	Return key	
②		Change the size of the character patterns. To change the size of one character, press to display and then select the character. The size of the selected character is changed.
	Size key	
③		Change the layout of the character patterns. • To arrange the character patterns on an arc, press , , or . : Make the arc flatter. : Make the arc rounder. • To arrange the character patterns on an incline, press . : Change the incline counterclockwise. : Change the incline clockwise. • : Reset the layout.
	Array key	
④		Change the spacing of the character patterns. • : Increase the character spacing. • : Decrease the character spacing. • To change the spacing after one character, press to display and then select the character. The spacing between the selected character and the next character is changed. ABCD E ↔ ABCDE A B C D E ↔ ABCDE • : Move the one selected character up. • : Move the one selected character down. • : Reset the spacing.
	Character spacing key	

No.	Display	Explanation
	Name	
⑤		Switch alignment. This function is available when multiple lines of characters are input. <ul style="list-style-type: none"> : Right alignment <p style="text-align: right;">ABCDE FGH IJKLMN</p> <ul style="list-style-type: none"> : Left alignment <p>ABCDE FGH IJKLMN</p> <ul style="list-style-type: none"> : Center alignment <p style="text-align: center;">ABCDE FGH IJKLMN</p>
	Alignment key	
⑥		Change the font of the characters. Depending on the font that was selected, it may not be possible to change the font. <ul style="list-style-type: none"> To change the font of one character, press to display and then select the character. The font of the selected character is changed.
	Font Type key	
⑦		Apply the character pattern editing.
	Set key	
⑧		Enter a space.
	Space key	
⑨		Make a new line.
	Line feed key	
⑩		Delete the character.
	Delete key	
⑪		Select the category of character.
	Category keys	
⑫		Select to edit all characters or one character. <ul style="list-style-type: none"> : Edit all characters. : Edit one character.
	Select one/all key	
⑬		Move the cursor and select a character.
	Character selection keys	

Selecting Frame Patterns

- 1 Press .
- 2 Press the key of the frame shape you want to embroider in the top part of the screen.
 - Various frame patterns are displayed at the bottom part of the screen.

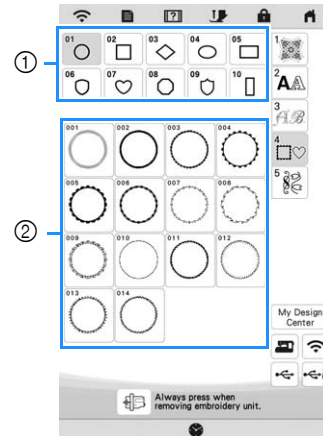

- ① Frame shapes
- ② Frame patterns
- 3 Press the key of the frame pattern you want to embroider.
 - The selected pattern is displayed on the screen.
- 4 Press .
- 5 Follow the steps from ④ to ⑦ of "Selecting Embroidery Patterns" on page 36.

Combining Patterns

Example:



1 Select a pattern and then press **Set**.

2 Press **Add**.

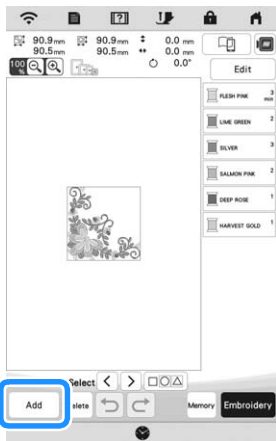

3 Press **A**.

4 Select **ABC** and enter "LOVE".

→ The characters you enter will be displayed in the center of the embroidery pattern area.

5 Press **Set**.

6 Press **Edit** and then press **Move**.

7 Use  to move the characters.

* Characters can also be moved by directly dragging them with your finger or the touch pen.

8 Press **OK**.

9 Press  to change the color of the characters.
(page 49)

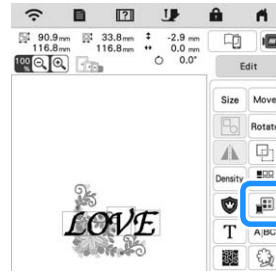

10 Press **OK**.



11 When all editing is finished, press **Embroider**.

Note

- Combined patterns will be embroidered in the order they were entered.

Selecting a Pattern

If multiple patterns have been combined, use

Select   to select the pattern to be edited. Patterns can also be selected by directly touching the screen with your finger or touch pen.

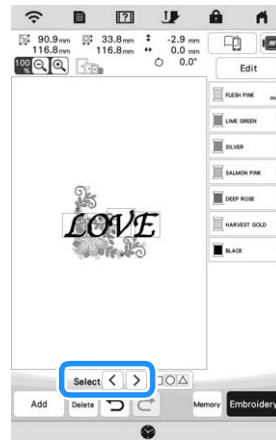

■ Selecting Multiple Patterns at the Same Time





Multiple patterns can easily be edited, for example, when moving patterns, if they are all selected together.

- 1 Press .

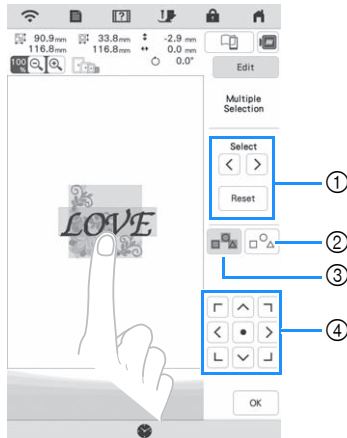

- 2 Touch each pattern to be selected.



- ① Press  or  to check the patterns to be selected, and then press . The selected patterns are highlighted with a red box. To deselect the selected patterns, press .
- ② Press this key to deselect all selected patterns.
- ③ Press this key to select all patterns in the pattern display area.
- ④ Patterns can be moved with this key.

Memo

- You can also select multiple patterns by dragging your finger to specify the area of selection.

- 3 Press  to return to the edit screen.

→ Each selected pattern is surrounded with a red box.

Memo

- The following functions are available while multiple patterns are selected.
 - Moving
 - Copying
 - Grouping
 - Stippling
 - Extracting pattern outlines

■ Grouping Patterns

If the multiple patterns are grouped, they can be edited as a single pattern.

- 1 Select patterns you want to group. (page 41)

- 2 Press .

→ The selected patterns are grouped.

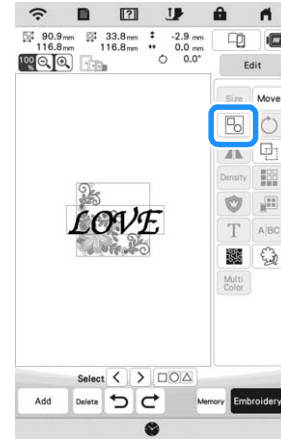

- * To ungroup a grouped pattern, select the grouped pattern, and then press . At this time, multiple patterns are selected. To cancel the multiple selection, press any other pattern or the blank area.

Memo

- The following functions are applied to all patterns in the grouped pattern.
 - Moving
 - Rotating
 - Appliqué
 - Border
 - Extracting pattern outlines
 - Simple stippling
 - Thread color changing

EDITING PATTERNS

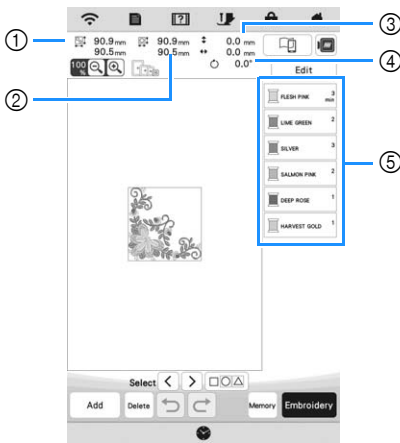

- ① Size of the entire combined pattern
- ② Size of the pattern currently selected
- ③ Distance from the center of the frame to the center of the pattern currently selected
- ④ Degree of rotation for the pattern currently selected
- ⑤ Color sequence and stitching times of each step of the pattern

Key Functions

Using these keys, you can edit the selected pattern. Press

to display the editing window.

Memo

- If a key display is grayed out, you cannot use that function with the selected pattern.

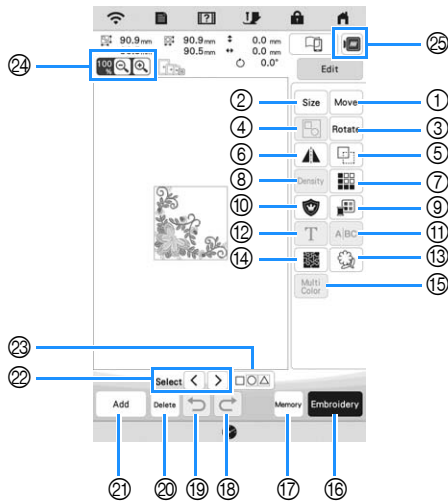

No.	Display	Explanation	Page
	Name		
①	<input type="button" value="Move"/>	Display the pattern moving window.	40
	Move key		
		<ul style="list-style-type: none"> • : Move the pattern in the direction shown by the arrow. • : Center the pattern. 	

No.	Display	Explanation	Page
	Name		
②	<input type="button" value="Size"/>	Display the pattern sizing window.	44
	Size key		
		<ul style="list-style-type: none"> • : Decrease the pattern proportionately. • : Decrease the pattern vertically. • : Decrease the pattern horizontally. • : Enlarge the pattern proportionately. • : Stretch the pattern vertically. • : Stretch the pattern horizontally. • : Change the size of the character patterns. • : Reset the size. (except for character patterns.) • : Move the pattern in the direction shown by the arrow. 	
③	<input type="button" value="Rotate"/>	Display the pattern rotating window.	—
	Rotate key		
		<ul style="list-style-type: none"> • <input type="button" value="Reset"/> : Reset the position. • : Move the pattern in the direction shown by the arrow. <p>You can also rotate the pattern by dragging the red point at the corners of the pattern.</p>	
④		Group selected multiple patterns.	41
	Group key		
⑤		Duplicate the pattern.	—
	Duplicate key		
⑥		Change the pattern to a horizontal mirror image.	—
	Horizontal mirror image key		
⑦		Make and edit the repeated pattern.	45
	Border key		
⑧	<input type="button" value="Density"/>	Change thread density for some alphabet character and frame patterns. Other patterns are available after enabling patterns to change the density.	44
	Density key		
⑨		Change the thread color.	49
	Thread palette key		
⑩		Create an appliqué outline of the pattern.	71
	Appliqué key		

No.	Display	Explanation	Page
	Name		
11		Separate the continuous character patterns to adjust the spacing or edit separately afterwards. <ul style="list-style-type: none"> : Select where the patterns is to be separated. : Separate the patten. A separated character pattern cannot be combined again. 	—
	Separate key		
12		Edit characters.	38, 43
	Letter Edit key		
13		Extract the outline of the pattern. The extracted pattern can be used with My Design Center.	101
	Outline key		
14		Create stippling around the pattern.	—
	Stippling key		
15		Press this key when you want to change the thread color, character by character in character embroidery. Since the machine stops at the end of each character, the upper thread can be changed as you embroider.	—
	Multi color key		
16		Proceed to the embroidery screen.	—
	Embroidery key		
17		Save a pattern in the machine's memory or USB media. The pattern can also be transferred to a computer via a wireless network connection.	80
	Memory key		
18		Redo the last operation that was undone.	—
	Redo key		
19		Undo the last operation.	—
	Undo key		
20		Delete the selected pattern (the pattern outlined by the red box).	—
	Delete key		
21		Add another pattern to the editing pattern.	40
	Add key		
22		Select the pattern to edit when there are multiple patterns.	40
	Pattern select key		
23		Make multiple patterns to be selected at the same time.	41
	Multiple selection key		
24		<ul style="list-style-type: none"> : Magnify the image. Use / / / to scroll through the display in any direction. : Demagnify the image (minimum: 100%). : Select the percent of magnification. 	—
	Magnify keys		
25		Preview the embroidery image.	44
	Image key		

■ Editing Letters

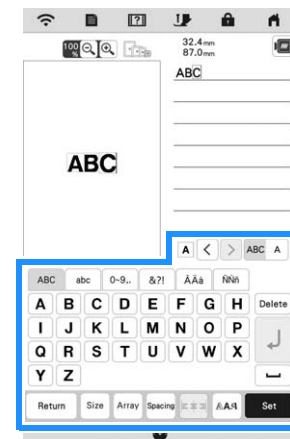
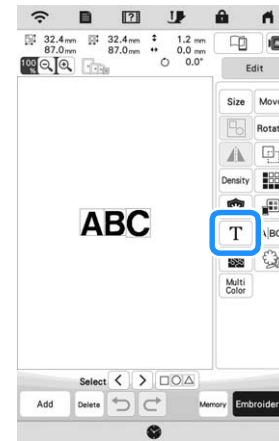

For details on input keys, refer to “Character Pattern Input Keys” on page 38.

Memo

- To edit character patterns with multiple lines in the edit screen, ungroup the pattern. (page 41)

Previewing the Pattern

1 Press .

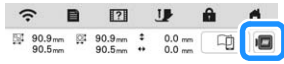

→ An image of the pattern as it will be embroidered appears.

2 Press  to select the frame used in the preview.

- * Frames displayed in gray cannot be selected.
- * Press  to enlarge the image of the pattern.
- * The pattern can be embroidered as it appears in the display.





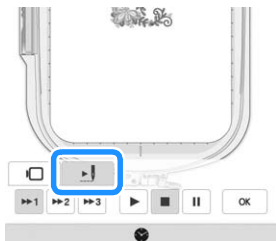

3 Press  to check the embroidering order.

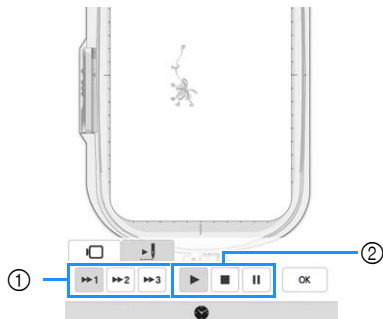

→ The stitch simulator screen appears.



- ① Simulation speed keys
- ② Operation keys
-  : Start the simulation at the set speed.
-  : Pause the simulation.
-  : Stop the simulation.

* Press  to return to the embroidery frame selection screen.

4 Press .

Changing the Size and the Density of the Pattern

If  is selected, you can change the pattern size while maintaining the thread density. The machine recalculates the stitch density automatically. With this function, the pattern will be enlarged or reduced at a larger ratio than with normal pattern resizing.



Note

- This function cannot be used with alphabet character patterns, frame patterns, repeated patterns or buttonhole patterns.
- Patterns with a large number of stitches (100,001 or more) cannot be resized while maintaining a thread density.

Memo

- Depending on the pattern, the size of the pattern increases up to 200% or reduces to 60%.
- You can also change the size by dragging the red point at the sides and corners of the pattern.



1 Select  in the size window.

- *  : Change the pattern size while maintaining the number of stitches. The thread density for the pattern increases or decreases.
- *  : Change the pattern size while maintaining the thread density. After the pattern size is changed, the thread density can be changed in the edit screen. The number of stitches is recalculated depending on the pattern size.

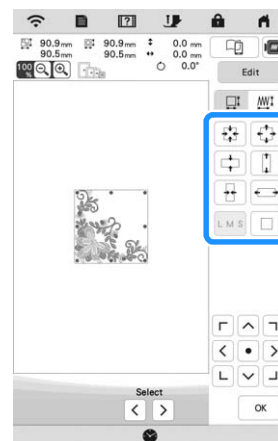
2 Select the direction in which to change the pattern size.



3 When you select  in step **1**, press , and then press  to change the thread density.

- *  : Make the pattern less dense.
- *  : Make the pattern more dense.

4 Press  .



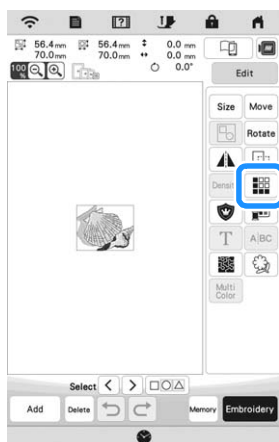

Creating Repeated Patterns

Using the border function, you can create repeated patterns. You can also adjust the spacing of the patterns.

1 Press , and then press .



2 Select the direction in which the pattern will be repeated.

- *  : Repeat the pattern above.
- *  : Delete above pattern.
- *  : Delete below pattern.
- *  : Repeat the pattern below.

Vertical direction

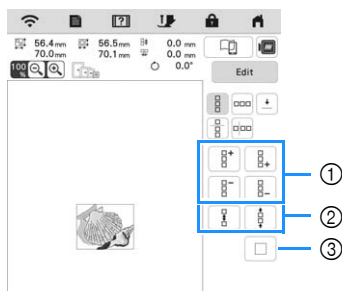

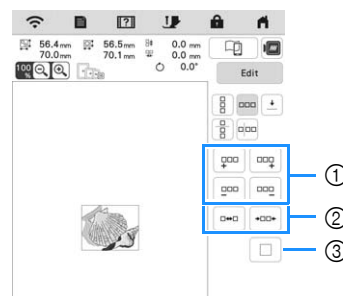

- ① Repeating and deleting keys
- ② Spacing keys
- ③ Key to cancel pattern repeating

Horizontal direction



- ① Repeating and deleting keys
- ② Spacing keys
- ③ Key to cancel pattern repeating

3 Adjust the spacing of the repeated pattern.

- *  : Widen spacing.
- *  : Tighten spacing.

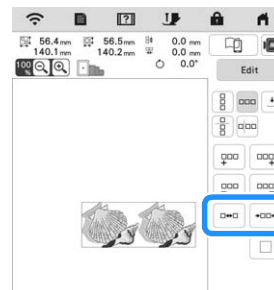

4 Complete repeated patterns by repeating steps **2** through **3**.

5 Press  .

■ Repeating One Element of a Repeated Pattern

You can select one element of a repeated pattern and repeat only that single element. This function allows you to create complex repeated patterns.

1 Press .

2 Choose the direction in which the repeated pattern will be cut.

*  : Cut horizontally.

*  : Cut vertically.

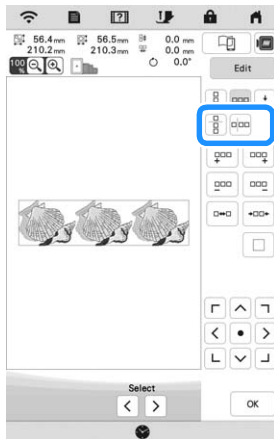

→ The pattern direction indicator will change depending on the direction selected.

3 Use  and  to select the cut line.

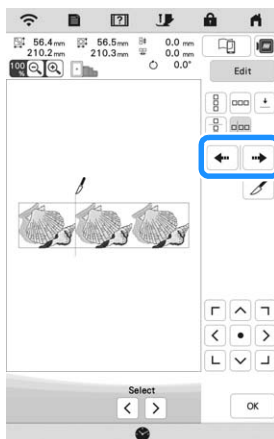

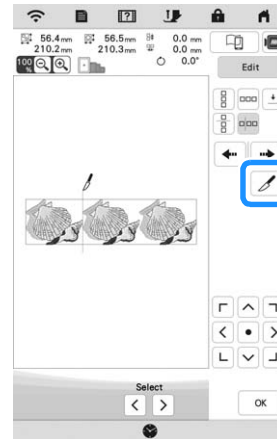

4 Press .



→ The repeated pattern will be divided into separate elements.

5 Press .

6 Use  and  to select the element to repeat.

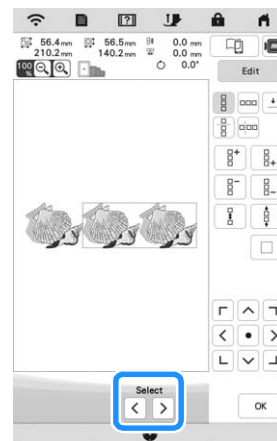

7 Repeat the selected element.

8 Press .

Color Sorting Repeated Patterns

Press **Embroidery** to automatically change the embroidering order of colors in combined border embroidery patterns so that the same color can be continuously embroidered. This allows you to continue embroidering without repeatedly changing the upper thread or changing the embroidering order manually.

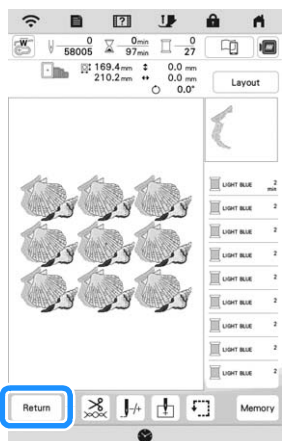
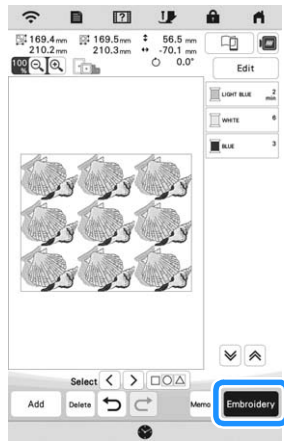

Memo

- When a grouped pattern is repeated, the embroidering order is changed in each pattern.
- If there are repeated patterns with other repeated patterns or other patterns, the embroidering order of only the repeated patterns is changed.

Assigning Thread Marks

By sewing thread marks, you can easily align patterns when rehooping the fabric to embroider a series. When embroidering is finished on a pattern, a thread mark in the shape of an arrow will be sewn using the final thread. When embroidering a series of patterns, use the point of this arrow for positioning the following designs to be embroidered.

1 Press .

2 Press .

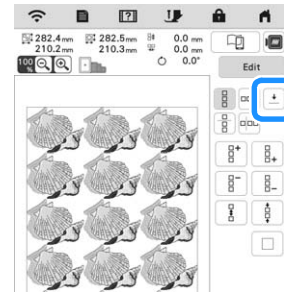

3 Press to select the thread mark to be sewn.

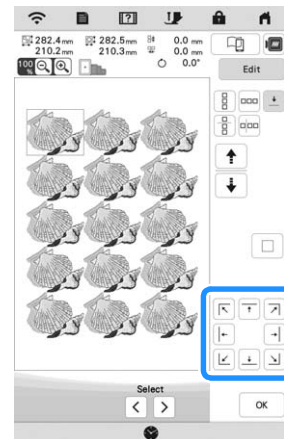

Memo

- When there are two or more elements, use or to select an element to assign a thread mark(s) to.

4 Press .

Embroidering the Pattern Repeatedly

After creating the repeated pattern, rehoop the embroidery frame and keep embroidering for the next pattern.

Memo

- The optional border frame allows you to easily rehoop the fabric without removing the embroidering frame from the machine.

1 Select the repeated pattern and assign the thread mark at the center of the bottom of the pattern.

* Refer to "Assigning Thread Marks" on page 47.

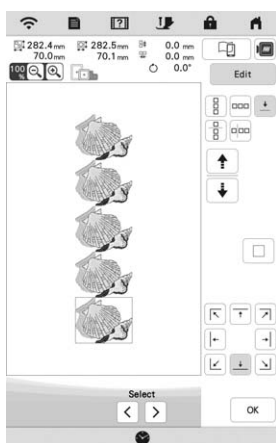

2 Press **OK**, then **Embroidery**.

3 Press the "Start/Stop" button to start embroidering.
→ When embroidering is finished, the thread mark is embroidered with the last thread color.

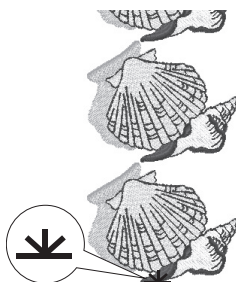

4 Remove the embroidery frame.

5 Rehoop the fabric in the embroidery frame.

Note

- Adjust the position of the fabric so that the embroidering area for the next pattern is within the embroidering area of the embroidery sheet.

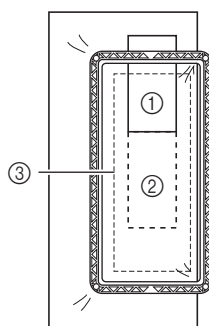

- ① Pattern embroidered first
- ② Position of pattern to be embroidered next
- ③ Embroidering area of embroidery sheet

6 Attach the embroidery frame to the machine, and then

press .

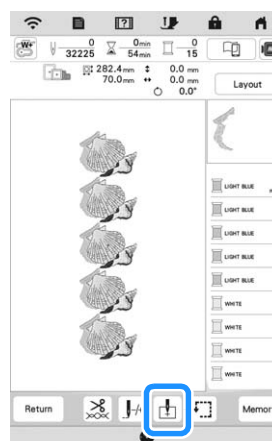

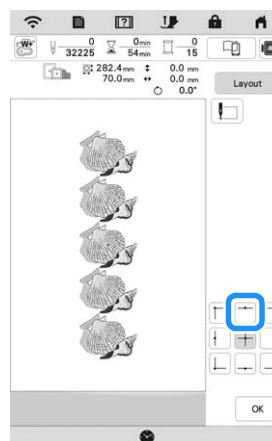

7 Press  to set the starting point to the center top of the pattern.



8 Press **OK**.

9 Press **Layout**, and then press **Move**.

10 Press  to move the embroidery frame until the thread mark on the fabric is aligned with the light of the LED pointer.

* To check the needle drop point with the light of the LED pointer, press .

 **Memo**

- For the accurate needle drop point, slowly turn the handwheel toward you (counterclockwise) to lower the needle. Then, turn the handwheel away from you (clockwise) until the mark on the handwheel is at the top. The carriage cannot move if the mark on the handwheel is not at the top.

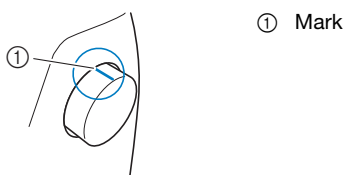

11 Press .

12 Remove the thread mark.

13 Start embroidering.

EDITING COLORS

Changing the Thread Color

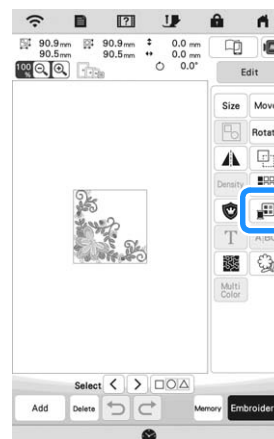

You can change the thread color from the thread colors assigned by the machine.

1 Press , and then press .



→ The thread color palette appears.

2 Press the color of the part to be changed.

* Press  or  to display the thread color that is not on the screen.

→ The selected thread color image appears.

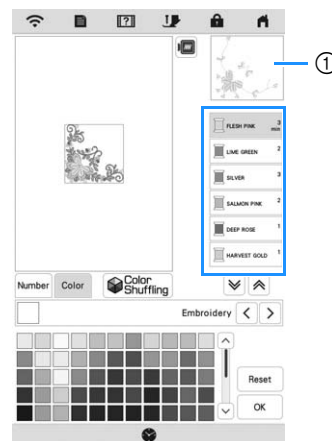

① Selected thread color image

 **Memo**

- When you directly touch a part of the pattern whose color is to be changed, the part can be selected and displayed.

- 3 Select a new color from the thread color palette, and then press **OK**.

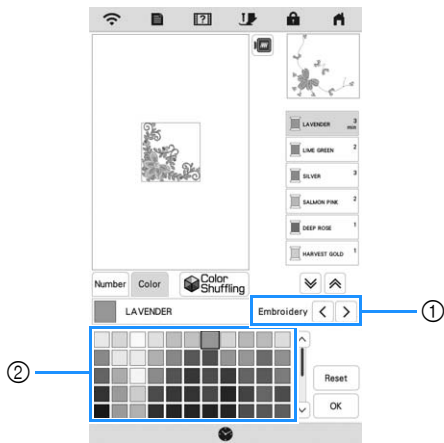

- 1 Thread brand for colors
- 2 Thread color palette

→ The display shows the changed colors.

- * To return to the original color, press **Reset**. If multiple colors have been changed, this command will return all colors to their original colors.

Memo

- Press **Number** to specify a thread color by entering its number. If you enter the wrong number, press **C**, and then enter the correct number. After entering the number, press **OK**.



Finding New Color Schemes with the Color Shuffling Function

With the color shuffling function, the machine suggests new color schemes for the embroidery pattern that you have selected. After you select the effect ([Random], [Vivid], [Gradient] or [Soft]), sample color schemes for the selected effect are displayed.

- 1 Press **Edit**, and then press . → The thread color palette screen appears.

- 2 Press .



Note

- This function may not be available depending on the pattern you select (ex. a repeated pattern, licensed pattern).

- 3 Select the thread brand for colors and the number of colors you want to create the pattern with.

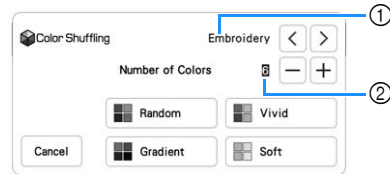

- 1 Thread brand for colors
- 2 Number of colors to be used

- 4 Select the desired effect.



- 1 Effects for schemes
 → If you select [Random] or [Gradient], the color specifying screen will appear.
 → If you select [Vivid] or [Soft], proceed to step **7**.

5 Press **Auto** **Manual** to set **Manual** and specify the thread color to use in the effect.

* If you don't need to specify the thread color, just set to **Auto**.

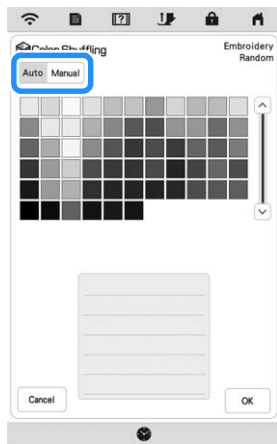

[Manual] setting for [Random]

You can select up to 6 colors to be used in the [Random] effect. The effect will be created using the selected colors.

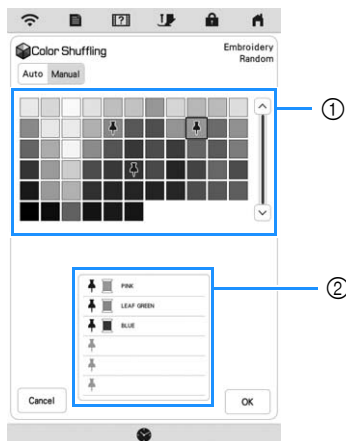

- ① Select colors from the palette.
- ② Selected colors are listed.

[Manual] setting for [Gradient]

You can select one color to be used in the [Gradient] effect. The effect will be created with a color you select.

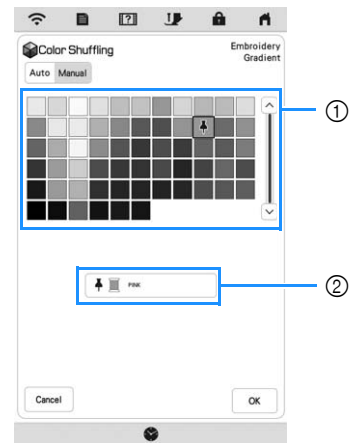

- ① Select a color from the palette.
- ② Selected color is displayed.

6 Press **OK**.

7 Select the color scheme from samples.

* Press **Refresh** to add the new schemes.



- ① Press to review the previous schemes.

Memo

- To temporarily register your favorite schemes, press (to release your favorite schemes, press again). 9 color schemes can be added. Press to check the registered favorite schemes.
- To cancel the registration, press .

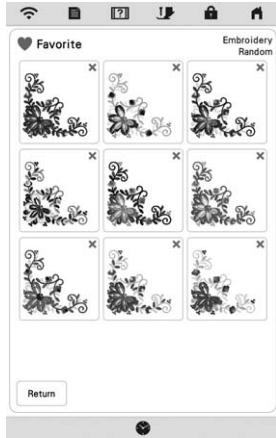

Note

- Maximum 20 pages of schemes can be reviewed.

8 Select the displayed color scheme.

- * : Return to the previous screen.
- * or : Display the other color schemes.
- * : Select the displayed color scheme.



→ The thread color palette screen will appear.

Thread Color Sorting

This function allows you to embroider while replacing the thread spool a minimal number of times.

Before starting to embroider, press in the embroidery screen to rearrange the embroidery order and sort it by thread colors.

- Press in the embroidery screen.

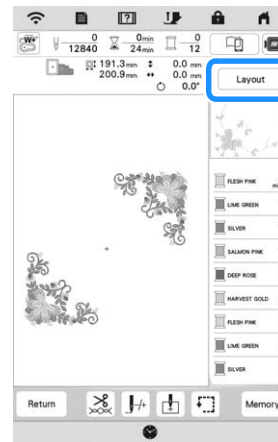

- Press .

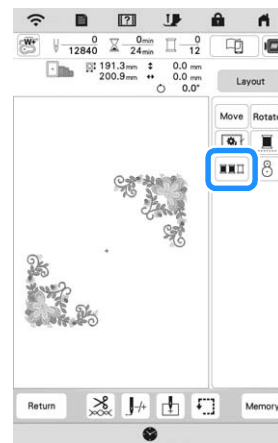

- * Press again to check the sorted thread colors.

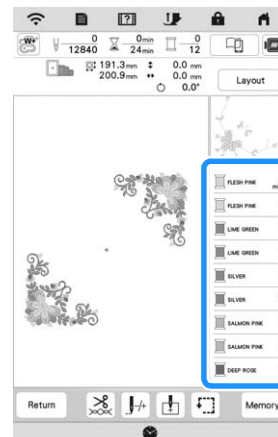

→ The embroidery color order is rearranged and sorted by thread colors.

- * Press **Layout**, then  to cancel color sorting and embroider with the original embroidery color order.

Note

- This function does not work on overlapping patterns.

VIEWING THE EMBROIDERY SCREEN

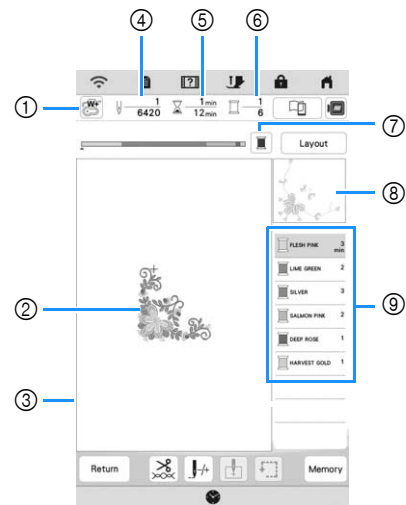

* This screen appears when embroidery starts.

- ① The presser foot symbol
Attach embroidery foot "W+" with LED pointer or embroidery foot "W" (sold separately) for all embroidery projects.
 - ② A preview of the pattern
 - ③ The boundary for embroidering with the selected frame in the settings screen
 - ④ Total number of stitches in the selected pattern and number of stitches that have already been embroidered
 - ⑤ The time necessary to embroider the pattern, and the time already spent embroidering the pattern (not including time for changing and automatically trimming the thread)
 - ⑥ The number of colors in the pattern, and the number of the color currently being embroidered
 - ⑦ Switch the progress bar (which shows the embroidering progress) between showing only one color or all colors. This key appears after starting embroidering or after pressing the  key.
 - ⑧ The part of the embroidery pattern that will be embroidered with the thread color at the top of the list
 - ⑨ The order for thread color changes and the embroidering time for each thread color
- * The displayed time is the approximate time that will be required. The actual embroidering time may be longer than the displayed time, depending on the embroidery frame that is used.

Key Functions





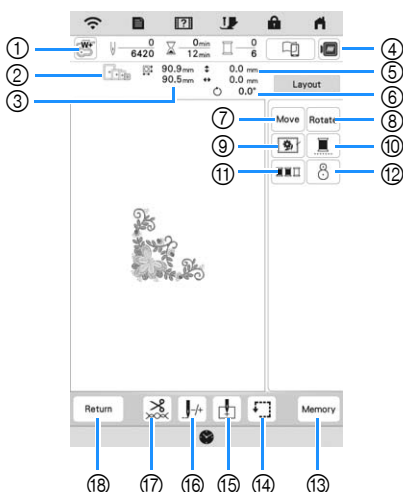

Using these keys, you can move or rotate pattern, etc.













Press  to display the editing window.

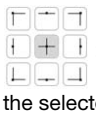

Note

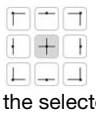
- Some operations or functions are not available for certain patterns. If the key display grayed out, you cannot use that function or operation with the selected pattern.

No.	Display	Explanation	Page
	Name		
①		Turn on the light of the LED pointer.	59
	Needle point check key	Press this key to check the needle drop point with the light of the LED pointer.	
②		Shows the embroidery frames that can be used for the selected pattern. Be sure to use the proper frame.	56
	Available frames		
③	90.9 mm ↕ 90.5 mm ↔	Shows the size of the selected pattern.	—
	Pattern size		
④		Preview the embroidery image.	44
	Image key		
⑤	0.0 mm 0.0 mm	Shows the distance between the embroidering position and the center (when the embroidery pattern is moved).	—
	Distance		
⑥	 0.0°	Shows the degree of rotation of the pattern.	—
	Degree		
⑦		Display the pattern moving window.	—
	Move key		
⑧		Display the pattern rotating window.	—
	Rotate key		
⑨		Add the basting stitch around the pattern. You can select the distance from the pattern to the basting stitching.	17, 70
	Basting key		

No.	Display	Explanation	Page
	Name		
⑩		Change the setting to embroider the pattern with a single color.	—
	Uninterrupted embroidery key	Press the key again to return to the original setting. Even if uninterrupted embroidering  has been set, the automatic thread cutting function and the thread trimming function can be used. The icons of the spool of thread are grayed out.	
⑪		Rearrange the embroidery order and sort it by thread colors.	52
	Thread color sorting key		
⑫		Press this key to align the embroidering position.	61
	Embroidery positioning key		
⑬		Save the pattern to the machine's memory or USB media. The pattern can also be transferred to a computer via a wireless network connection.	80
	Memory key		
⑭		Check the position of the pattern.	61
	Trial key	<ul style="list-style-type: none">  : Move the carriage to trace the embroidery area of the pattern. This allows you to check that there is enough space to embroider the pattern.  : Move the carriage to the selected position. 	
⑮		Specify the needle start position.	77, 78
	Starting point key	<ul style="list-style-type: none">  : Set the needle start position to the lower-left corner of the pattern. This setting is useful when connecting patterns since it allows you to continue embroidering until the first stitch of the next pattern.  : Move the carriage to the selected position. 	
⑯		Move the needle forward or back in the pattern; useful if the thread breaks while embroidering or if you want to start again from the beginning.	66
	Forward/Back key		
⑰		Set automatic thread cutting, thread trimming or the thread tension. For embroidery, these functions are set automatically.	73-76
	Cut/Tension key		
⑱		Return to the edit screen.	—
	Return key		



PREPARING THE FABRIC

⚠ CAUTION

- Use fabrics with a thickness of less than 3 mm (approx. 1/8 inch). Using fabrics thicker than 3 mm (approx. 1/8 inch) may cause the needle to break.

💡 Note

- When using layers with thicker batting etc., you can embroider more attractive finishes by adjusting the embroidery presser foot height in the embroidery settings screen.

Press , and use  and  in the [Embroidery Foot Height] in the embroidery settings screen. Adjust the presser foot height for thick or puffy fabrics.



- To increase the space between the embroidery foot and the right side of the fabric, set the [Embroidery Foot Height] to a larger number.
- In the case of thick terry cloth towels, we recommend that you place a piece of water soluble stabilizer on the top surface of the towel. This will help to reduce the nap of the toweling and result in more attractive embroidery.

Attaching Iron-on Stabilizers (Backing) to the Fabric

⚠ CAUTION

- Always use a stabilizer material for embroidery when embroidering on stretch fabrics, lightweight fabrics, fabrics with a coarse weave, or fabrics which cause pattern shrinkage. Otherwise, the needle may break and cause injury.

1 Iron the iron-on stabilizer material to the wrong side of the fabric.

- Use a piece of stabilizer which is larger than the embroidery frame being used.

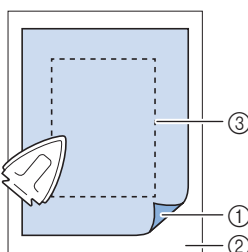

- ① Fusible side of stabilizer
- ② Fabric (wrong side)
- ③ Size of the embroidery frame

📖 Memo

- When embroidering small pieces of fabric that cannot be hooped in an embroidery frame, use stabilizer material as a base. After lightly ironing the fabric to the stabilizer material, hoop it in the embroidery frame. If stabilizer material cannot be ironed onto the fabric, attach it with a basting stitch. After completing the embroidery, remove the stabilizer material carefully.

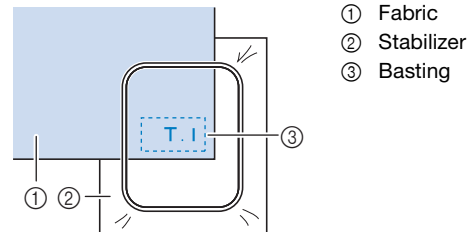

- When embroidering on thin fabrics such as organdy or lawn, or on napped fabrics such as towel or corduroy, use water soluble stabilizer (sold separately) for best results. The water soluble stabilizer material will dissolve completely in water, giving the project a more attractive finish.

Hooping the Fabric in the Embroidery Frame

Types of Embroidery Frames

Optional embroidery frames can be used. When choosing frames that do not appear on the screen, be sure to check the design size of the embroidery field of the optional frame. Check with your authorized Brother dealer for frame compatibility.

Select a frame that matches the pattern size. Available frame options are displayed on the LCD.

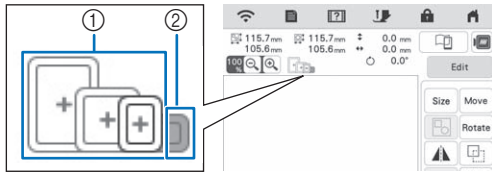

- ① Highlighted: Can be used
- ② Shaded: Cannot be used

Inserting the Fabric

Note

- If the fabric is not securely held in the embroidery frame, the pattern will embroider out poorly. Insert the fabric on a level surface, and gently stretch the fabric taut in the frame.
- Embroidery frames with factory-coded stickers can be used with the application (My Design Snap).

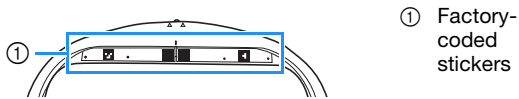

- ① Factory-coded stickers

1 Lift-up and loosen the frame adjustment screw and remove the inner frame.

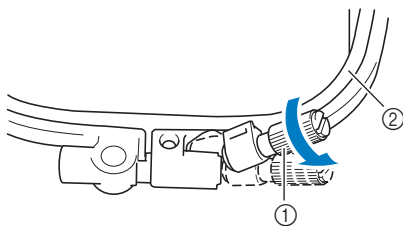

- ① Frame adjustment screw
- ② Inner frame

2 Lay the fabric right side up on top of the outer frame.

3 Insert the inner frame making sure to align the inner frame's \triangle with the outer frame's ∇ .

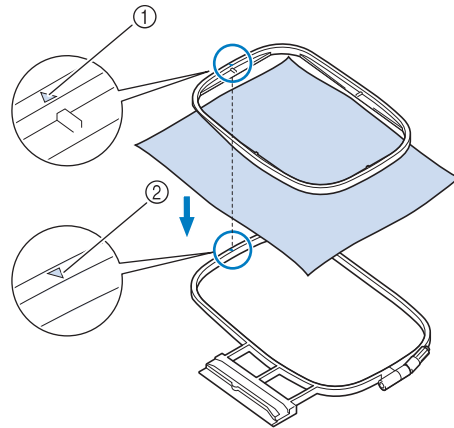

- ① Inner frame's \triangle
- ② Outer frame's ∇

4 Slightly tighten the frame adjustment screw.

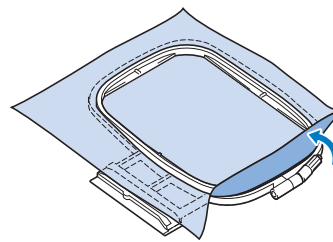

5 Gently smooth out the fabric. Make sure fabric is flat and without wrinkles.

- * After stretching the fabric, make sure the fabric is taut.

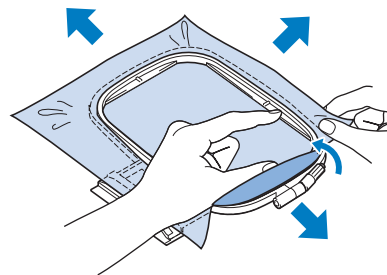

- * Make sure the inside and outside frames are even before you start embroidering.

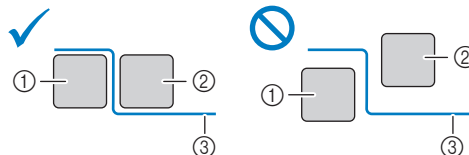

- ① Outer frame
- ② Inner frame
- ③ Fabric

- 6** Tighten the frame adjustment screw to keep the fabric from loosening while stitching.

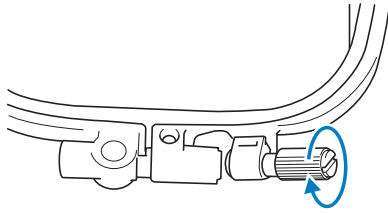

- 7** Return the frame adjustment screw to its initial position.

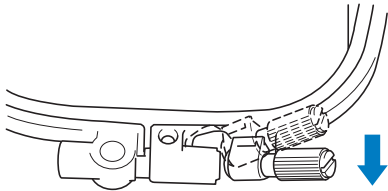

Memo

- You can use the disc-shaped screw driver, when you loosen or tighten the frame adjustment screw.

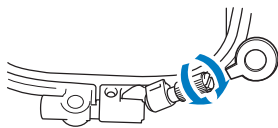

Using the Embroidery Sheet

When you want to embroider the pattern in a particular place, use the embroidery sheet with the frame.

- 1** With a chalk pencil, mark the area of the fabric you want to embroider.

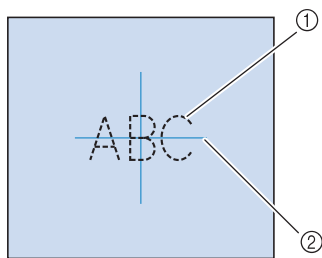

- ① Embroidery pattern
- ② Mark

- 2** Place the embroidery sheet on the inner frame. Align the guide lines on the embroidery sheet with the mark you made on the fabric.

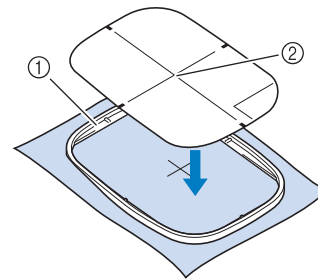

- ① Inner frame
- ② Guide line

- 3** Gently stretch the fabric so there are no folds or wrinkles, and press the inner frame into the outer frame.

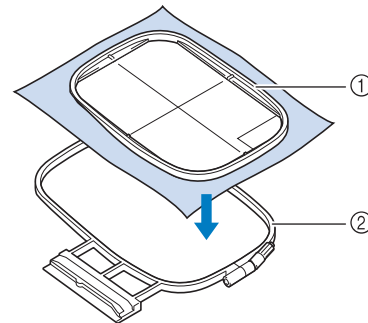

- ① Inner frame
- ② Outer frame

- 4** Remove the embroidery sheet.

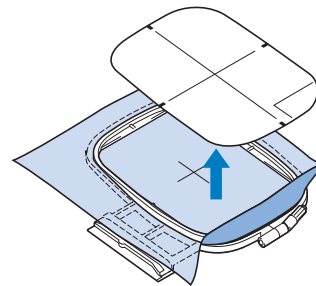

ATTACHING THE EMBROIDERY FRAME



Note

- Wind embroidery bobbin thread and insert the bobbin before attaching the embroidery frame. Check that there is enough thread in the bobbin.

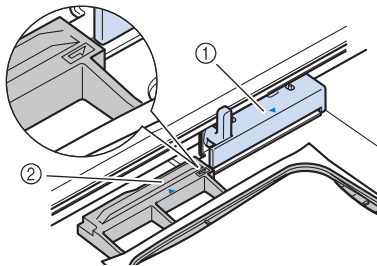
- 1 Press  (Presser foot lifter button) to raise the presser foot.
- 2 Align the embroidery frame guide with the right edge of the embroidery frame holder.



- ① Embroidery frame holder
- ② Embroidery frame guide

- 3 Slide the embroidery frame into the holder, making sure to align the embroidery frame's  with the holder's .

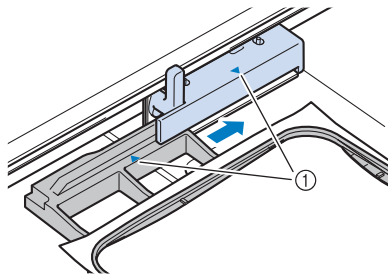

- ① Arrow mark

- 4 Lower the frame-securing lever to be level with the frame to secure the embroidery frame in the embroidery frame holder.

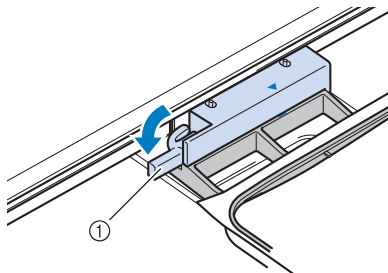

- ① Frame-securing lever

Removing the Embroidery Frame

- 1 Press  (Presser foot lifter button) to raise the presser foot.
- 2 Raise the frame-securing lever.

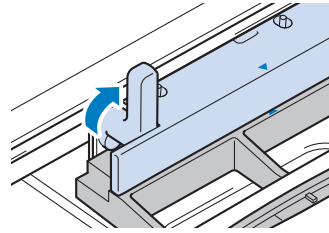

- 3 Pull the embroidery frame toward you.

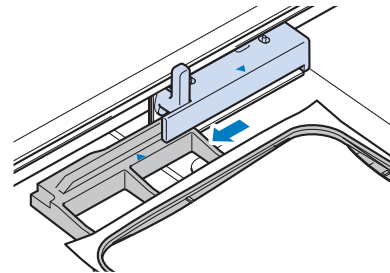

CONFIRMING THE PATTERN POSITION

The pattern is normally positioned in the center of the embroidery frame. If the pattern needs to be repositioned for better placement on the garment, you can check the layout before starting embroidery.

Checking the Needle Drop Point with the Embroidery Foot “W+” with LED Pointer

- 1 Press in the embroidery screen.
→ The LED pointer indicates the needle drop point.

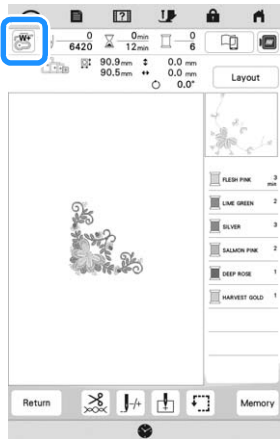

Memo

- When the LED pointer turns on, the presser foot height is automatically adjusted according to the fabric thickness.
- appears when the embroidery foot “W+” with LED pointer is attached to the machine.
- If is not displayed, you cannot use the LED pointer.
- The LED pointer turns off automatically by lowering the presser foot or returning to the previous page.

Note

- With spongy fabric, the position may not be accurate due to the various depths of the fabric.
- With fabric that has a very uneven surface such as quilting, the fabric thickness may not be correctly measured. In this case, the pointer indication should be used only as a reference.

Adjusting the LED Pointer

Adjust the LED pointer if it indicates a point different than the actual needle drop point. Before adjusting the LED pointer, mark the actual needle drop point on the fabric to be embroidered, and attach the embroidery frame.

- 1 Press .
→ The settings screen appears.
- 2 Press .
→ The embroidery settings screen appears.

- 3 Display [Embroidery Foot with LED Pointer Adjustment] in the embroidery setting screen.

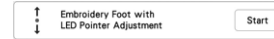

Note

- As a default, appears gray. After the embroidery foot “W+” with LED pointer is attached to the machine, the key becomes available and settings can be specified.

- 4 Press .

→ The Embroidery Foot “W+” with LED Pointer Adjustment screen appears.



- 1 LED pointer adjustment

Note

- The specified setting is saved in the machine’s memory. This is useful for positioning during continuous embroidering.
- For normal use, return the setting to [00].

- 5 Use or to adjust the LED pointer so that it indicates the actual needle drop point.

Memo

- In order to more accurately check the needle drop point, turn the handwheel toward you (counterclockwise) to lower the needle.

- 6 Press to return to the original screen.

Adjusting the Brightness of the LED Pointer

- 1 Follow the steps from 1 to 3 of “Adjusting the LED Pointer” on page 59 to display the embroidery foot with LED pointer adjustment screen.

- 2 Use or to adjust the brightness of the LED pointer.

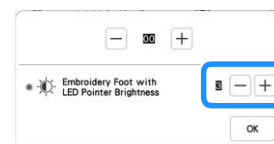

- 3 Press to return to the original screen.

Displaying a Background Image

Using a special application downloaded to a smartphone or tablet, you can transfer a photo of the hooped fabric to be embroidered to the machine to be used as a background image.

The embroidery frame is displayed in the application. You can see how the pattern will be arranged on the actual fabric.

Note

- The wireless network settings must first be specified on the machine. Refer to “WIRELESS NETWORK CONNECTION FUNCTIONS” on page 20.
- Embroidery frames with factory-coded stickers can be used with the application (My Design Snap).

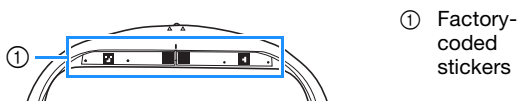

■ Displaying the Background Image on the Screen of the Machine

- 1 Select the pattern. (page 36)
- 2 Photograph the fabric in the frame with the easy mode of the application, and then transfer it to the machine.

For a detailed procedure, refer to the application.

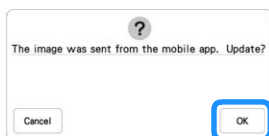

- 3 Press .

* Attach the frame used in the image before pressing



→ The transferred background image appears on the screen of the machine.

Memo

- To hide the background image, press .
- Press  to display the background image again.
- The transferred background image includes the embroidery frame display.

■ Calibrating the Position of the Background Image

By calibrating the position of the background image transferred to the machine, the pattern can be positioned more accurately.

- 1 Select a pattern. (page 36)
- 2 Set the application to advanced mode, attach the embroidery positioning sticker to the fabric in the hoop, take the photo of the background, and with the advanced mode of the application, transfer it to the machine.

For a detailed procedure, refer to the application.

- 3 Press .

* Attach the frame used in the image before pressing

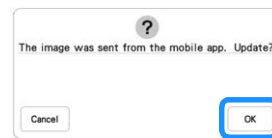

→ The carriage will move, and the LED pointer will turn on.

- 4 Use  to align the LED pointer with the center of the larger circle in the embroidery positioning sticker.

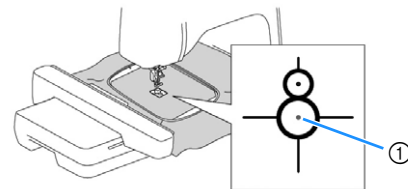

- ① Center of the larger circle in the embroidery positioning sticker

Memo

- The position can also be calibrated by lowering the needle with the handwheel. This method enables more accurate positioning. Slowly turn the handwheel toward you (counterclockwise) to check the needle drop point. Then, turn the handwheel away from you (clockwise) until the mark on the handwheel is at the top. The carriage cannot move if the mark on the handwheel is not at the top.

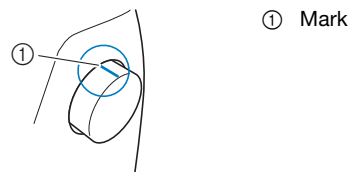

- 5 Press .

→ The position of the background image is calibrated.

Aligning the Embroidering Position

- 1 Calibrate the position of the background image. (page 60)
- 2 Press .

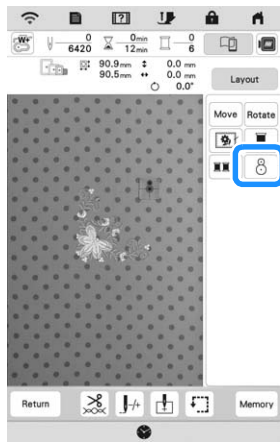

Memo

- The orientation of the pattern will change depending on the orientation of the embroidery positioning sticker.

- 3 When the following message appears, press .

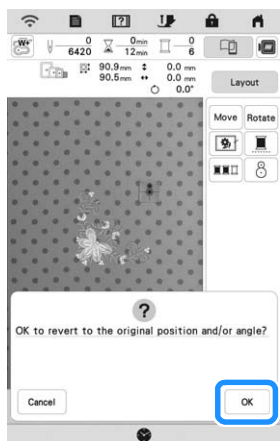

- 4 Select the position to be set as the reference point.





- 5 Press .

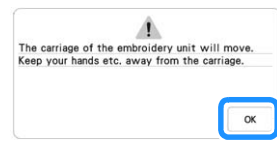

→ When the following message appears, press .



- 6 Remove the embroidery positioning sticker, and then start embroidering.

* To remove the embroidery positioning sticker more easily, press  so that the embroidery frame moves slightly forward and away from under the needle. After the embroidery positioning sticker is removed, press .



Checking the Pattern Position

The carriage moves and shows the pattern position. Watch the embroidery frame closely to make sure the pattern will be embroidered in the right place.

- 1 Press .

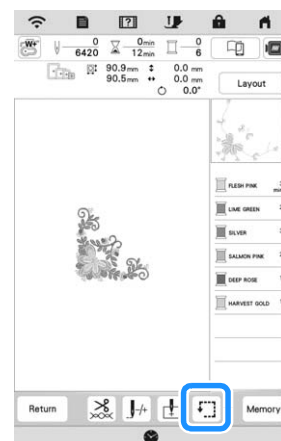

- 2 From , press the key for the position that you want to check.

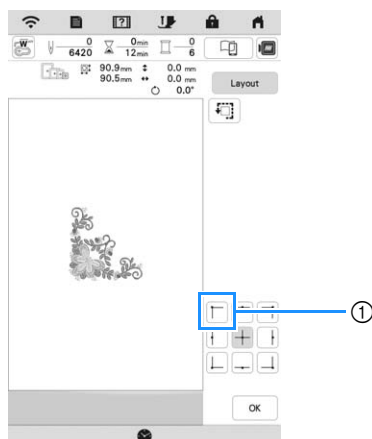

- ① Selected position
→ The carriage will move to the selected position on the pattern.

Memo

- To see the entire embroidering area, press . The carriage moves and shows the embroidery area.

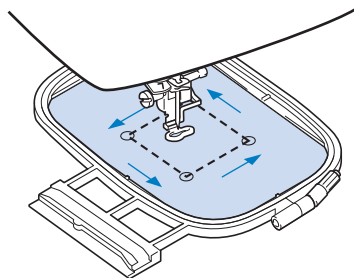

CAUTION

- Make sure the needle is up when the carriage is moving. If the needle is down, it could break and result in injury.

- 3 Press .

EMBROIDERING A PATTERN

Embroidering Attractive Finishes

Many factors are involved in achieving a beautiful embroidery result. Using the appropriate stabilizer (page 55) and hooping the fabric in the frame (page 56) are two important factors mentioned earlier. Another important point is the appropriateness of the needle and thread being used. See the explanation of threads below.

Thread	Upper thread	Use embroidery thread intended for use with this machine.
	Bobbin thread	Use embroidery bobbin thread intended for use with this machine.

Memo

- If you use threads other than those listed above, the embroidery may not embroider out correctly.

Bobbin case (recommended for embroidering with included 90 weight bobbin thread)

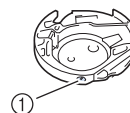

- ① Bobbin case (no color on the screw)

The included bobbin case is set for 90 weight bobbin thread. When you use different weights of bobbin thread, the tension screw on this bobbin case can be adjusted if necessary. For details, refer to “Adjusting the Bobbin Case (with No Color on the Screw)” on page 75.

CAUTION

- When embroidering on large garments (especially jackets or other heavy fabrics), do not let the fabric hang over the table. Otherwise, the embroidery unit cannot move freely and the embroidery frame may strike the needle, causing the needle to bend or break and possibly cause injury. Place the fabric so that it does not hang off the table or hold the fabric to keep it from dragging.

■ Embroidery Needle Plate Cover

Under some conditions, based on the type of fabric, stabilizer, or thread being used, there may be some looping in the upper thread. In this case, attach the included embroidery needle plate cover to the needle plate. Attach the cover by inserting the two projections on

the underside of the cover into the notches on the needle plate as shown below.

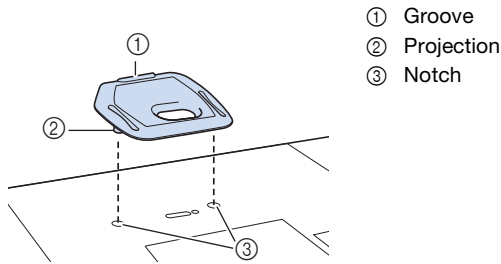

To remove the embroidery needle plate cover, place your fingernail in the groove and lift the plate out.

CAUTION

- Push the embroidery needle plate cover as far as possible to attach it. If the embroidery needle plate cover is not securely attached, it may cause the needle to break.

Embroidering Patterns

- 1 Prepare embroidery threads of the colors shown on the screen.

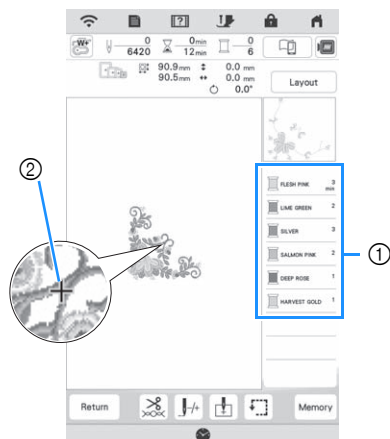

- 1 Embroidery color order
- 2 Cursor

Memo

- The [+] cursor moves over the pattern, showing which part of the pattern is being embroidered.

- 2 Using the automatic needle threader, thread the machine for the first color. (page 28)

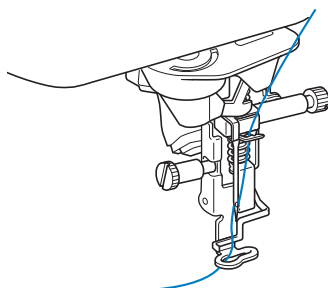

- 3 Lower the presser foot, then press the "Start/Stop" button to start embroidering.

→ When the first color is completely embroidered, the machine will automatically trim the threads and stop. The presser foot will then automatically be raised. On the embroidery color order display, the next color will move to the top.

Memo

- If you want to get more attractive finishes, try the procedures below;
 - After 5-6 stitches, press the "Start/Stop" button again to stop the machine.
 - Trim the excess thread at the beginning of the pattern. If the excess thread tail is under the embroidery foot, raise the embroidery foot, then trim the excess thread.

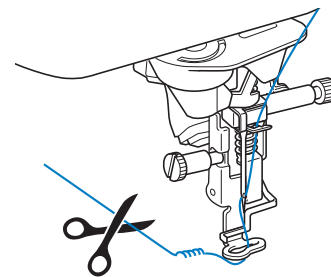

- If there is thread left over from the beginning of embroidering, it may be embroidered over as you continue embroidering the pattern, making it very difficult to deal with the thread after the pattern is finished. Trim the threads at the beginning of each thread change.

- 4 Remove the upper thread for the first color from the machine. Thread the machine with the next color.

- 5 Repeat the same steps for embroidering the remaining colors.

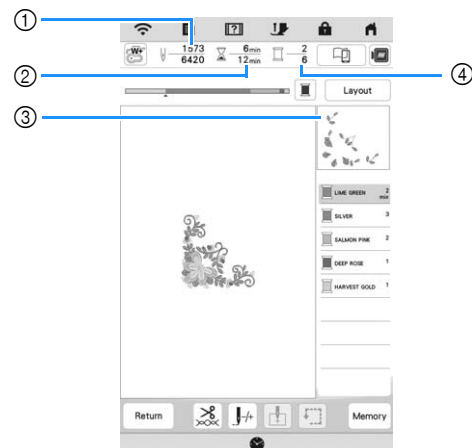

- 1 Current stitch numbers/Total stitch numbers
- 2 Current time/Total time
- 3 Part of pattern to be embroidered next
- 4 Embroidered colors/Total colors

→ When the last color is embroidered, [Finished embroidering] will appear on the display. Press



, and the display will return to the original screen.

Memo

- The thread trimming function is originally set to trim excess thread jumps (threads linking parts of the pattern, etc.). Depending on the type of thread and fabric that are used, an end of upper thread may remain on the surface of the fabric at the beginning of the stitching. After embroidering is finished, cut off this excess thread.

If the setting has been turned off, trim the excess thread jumps using scissors after the pattern is finished. Refer to page 76 for information on the thread trimming function.

CAUTION

- Do not press  (Thread cutter button) after the threads have been cut. Doing so could tangle the thread or break the needle and damage the machine.
- Do not press  (Thread cutter button) when there is no fabric set in the machine or during machine operation. The thread may tangle, possibly resulting in damage.

Using Appliqués

When the color embroidering order display shows

 (APPLIQUE MATERIAL),

 (APPLIQUE POSITION) or

 (APPLIQUE)], follow the procedure below.

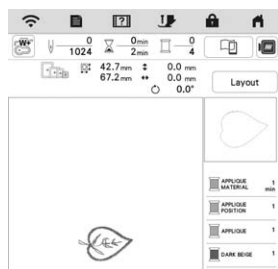

Required materials

- Fabric for the appliqué piece
- Fabric for the appliqué base
- Stabilizer material
- Fabric glue or temporary spray adhesive
- Embroidery thread

Note

- The correct names and numbers of the thread colors to be used will not appear. Use the thread colors depending on those in the appliqué pattern.

1. Creating an Appliqué Piece

- 1 Attach stabilizer material to the wrong side of the fabric for the appliqué piece.
- 2 Sew the cutting line of the appliqué piece. Remove the fabric for the appliqué piece from the embroidery frame, and then carefully cut along the sewn cutting line.

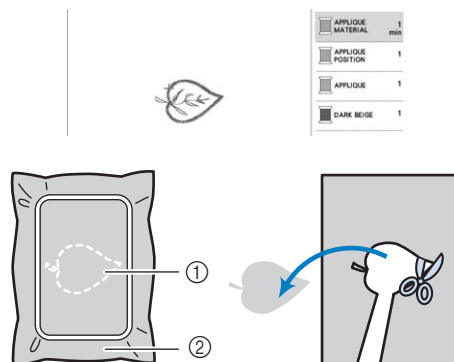

- ① Outline of appliqué
- ② Fabric for appliqué piece

Note

- If the appliqué piece is cut out along the inside of the cutting line, it may not be correctly attached to the fabric. Therefore, carefully cut out the appliqué piece along the cutting line.
- After cutting out the appliqué piece, carefully remove the thread.

2. Sewing the Appliqué Position on the Base Fabric

- 1 Attach stabilizer material to the wrong side of the fabric for the appliqué base.
- 2 Sew the appliqué position.

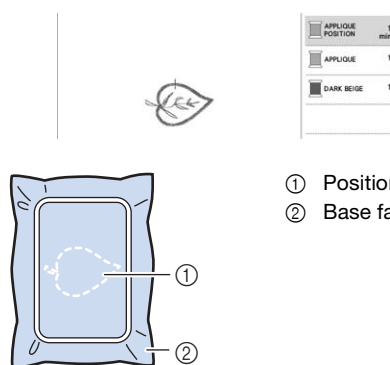

- ① Position of appliqué
- ② Base fabric

- 3 Remove the embroidery frame from the embroidery unit.

Note

- Do not remove the base fabric from the embroidery frame until all embroidering is finished.

■ 3. Affixing the Appliqué Piece to the Base Fabric

- 1 Lightly apply fabric glue or temporary spray adhesive to the back of the appliqué piece, and then attach it to the base fabric within the outline of the position sewn in step 2 of "2. Sewing the Appliqué Position on the Base Fabric".

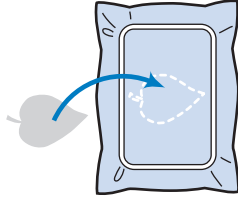

Note

- If the appliqué piece cannot be attached to the base fabric with fabric glue or temporary spray adhesive, securely baste it in place with basting stitches.
- If thin fabric is used for the appliqué piece, reinforce and secure it in place with an iron-on adhesive sheet. An iron can be used to attach the appliqué piece to the appliqué location.

- 2 After the appliqué piece is attached, attach the embroidery frame to the machine. Thread the machine with the embroidery thread, lower the presser foot lever, and then press the "Start/Stop" button to embroider the appliqué.

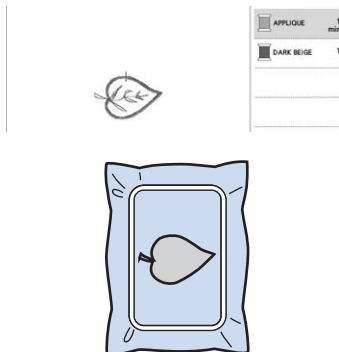

■ 4. Embroidering the Remainder of the Pattern

- 1 Change the embroidery thread according to the embroidery color order display, and then finish embroidering the remainder of the pattern.

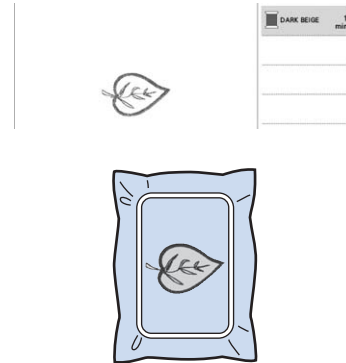

Memo

- Since glue may become attached to the presser foot, needle or needle plate, clean off any glue after finishing embroidering the appliqué pattern.
- For best results, trim all excess threads each time the thread color is changed.

ADJUSTMENTS DURING THE EMBROIDERY PROCESS

If the Thread Breaks or the Bobbin Runs out of Thread During Embroidering

1 Redo the upper threading or replace the bobbin.

If the upper thread breaks, stop the machine, trim the bobbin thread, and then rethread the machine.

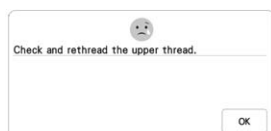

If the bobbin thread is almost empty or broken, press



of the displayed message, remove the embroidery frame, and then replace the bobbin.



Note

- If [Upper and Bobbin Thread Sensor] in the settings screen of the machine is set to [OFF], the message shown above does not appear.

2 Press .

3 Press , , , or to move the needle back the correct number of stitches before the area where the thread broke, and then press .







- Press  to restart from the beginning.



Note

- It is recommended to stitch over the top of the last two or three stitches for complete coverage.

Memo

- If you cannot move back to the spot where the thread broke, press  or  to select the color and move to the beginning position of that color, then use , , , or  to move ahead to slightly before where the thread broke.

4 Lower the presser foot and press the "Start/Stop" button to continue embroidering.

Resuming Embroidery after Turning off the Power

The current color and stitch number are saved when embroidery is stopped. The next time the machine is turned on, you have the option to continue or delete the pattern.

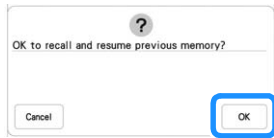



Chapter **3**
Advanced Embroidery

VARIOUS EMBROIDERING FUNCTIONS



Basting Embroidery

Before embroidering, basting stitches can be sewn along the outline of the pattern. This is useful for embroidering fabric that cannot have stabilizer material affixed with an iron or adhesive. Basting stitches can be used to attach material that cannot be hooped to stabilizer, making it possible to be embroidered.

Note

- It is recommended to finish combining and editing the pattern before selecting the basting setting. If the pattern is edited after selecting the basting setting, the basting and pattern may become misaligned, and the basting under the pattern may be difficult to remove after embroidering is complete.

1 Press .



2 Use  and  to specify the distance from the pattern to the basting stitching.



Memo

- The higher the setting, the farther the basting is from the pattern.
- The setting remains selected even if the machine is turned off.

3 Press  to return to the embroidering screen.

4 Press , and then press  to select the basting setting.

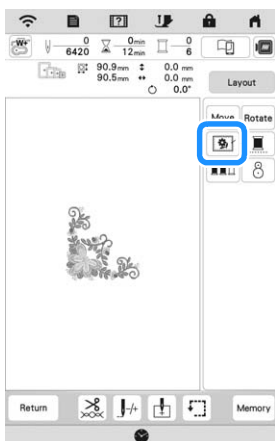

Note

- When  is pressed, the pattern is moved to the center. After selecting the basting setting, move the pattern to the desired position.

→ Basting is added to the beginning of the embroidering order.

5 Press the "Start/Stop" button to start embroidering.

6 When embroidering is finished, remove the basting stitching.



Creating an Appliqué Piece

Creating an appliqué piece is convenient for fabrics that cannot be embroidered or when you wish to attach an appliqué to a garment.

Creating an Appliqué Piece

The following pattern will be used to create an appliqué piece.



Note

- Felt or denim fabrics are recommended to make the appliqué piece. Depending on the pattern and fabric used, lighter weight fabrics may cause the stitching to appear smaller.
- For best results, be sure to use stabilizer material for embroidering.
- When making appliqué pieces, do not use the optional border embroidery frame. Depending on the pattern density and fabric used, shrinkage of the stitching may occur.

1 Select the pattern, and edit it if necessary.

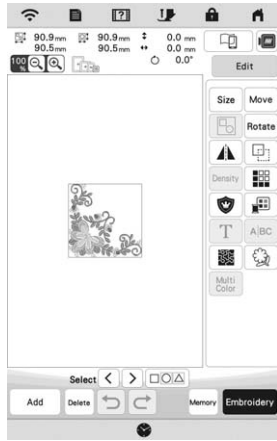

Note

- Finish combining and editing the pattern before selecting the appliqué setting. If the pattern is edited after selecting the appliqué setting, the appliqué stitching and pattern may become misaligned.
- Since an outline is added, the pattern for an appliqué piece (when the appliqué setting is selected) will be larger than the original pattern. First, adjust the size and position of the pattern as shown below.

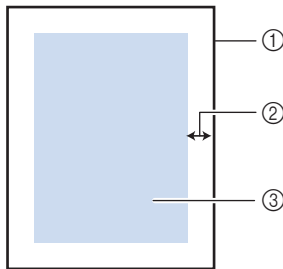

- ① Embroidering area
- ② About 1cm (1/2 inch)
- ③ Pattern size

2 Press to display the settings screen.

3 Use and to specify the distance from the pattern to the appliqué outline.



4 Press .

5 Press and then, press to position the satin stitching around design.

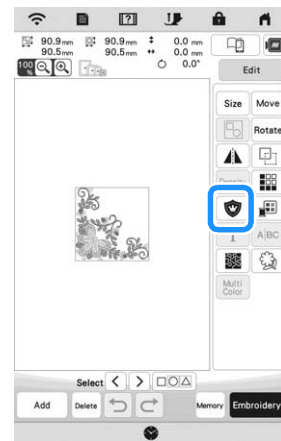

Note

- When is pressed, the pattern is moved to the center. After selecting the appliqué setting, move the pattern to the desired position.

→ The steps for creating the appliqué piece are added to the embroidering order.

Memo

- The appliqué setting is applied only to the selected pattern. To select multiple patterns, refer to "Selecting Multiple Patterns at the Same Time" on page 41.
- Three steps are added to the embroidering order: appliqué cutting line, position of pattern placement on the stabilizer material, and appliqué stitching.

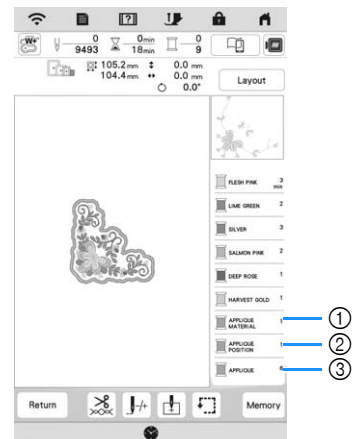

- ① Cutting line for appliqué
- ② Position of pattern placement on stabilizer material
- ③ Appliqué stitching

Note

- An appliqué piece cannot be created if the pattern is too large or too complicated or a combined pattern is separated. Even if the selected pattern fits within the embroidering area, the entire appliqué pattern may exceed the embroidering area when the outline is added. If an error message appears, select a different pattern or edit it.

- 6 Fuse or stick a piece of stabilizer to the back of the felt or denim fabric to be used as the appliqué piece.
- 7 Hoop the fabric for the appliqué piece in the embroidery frame, attach the embroidery frame to the machine, and then start embroidering.
- 8 After the pattern is embroidered, thread the machine with the thread for the cutting line, and then sew the cutting line (APPLIQUE MATERIAL).

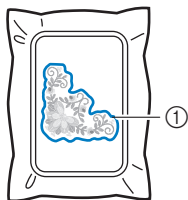

① Cutting line for appliqué

Memo

- We recommend using thread for the cutting line that is closest to the color of the fabric.

- 9 Remove the fabric for the appliqué piece from the embroidery frame, and then carefully cut along the stitching. After cutting, carefully remove all of the cutting line thread.

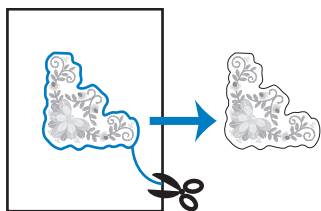

Note

- Depending on the pattern density and fabric used, there may be shrinking of the pattern, or the appliqué may be misaligned with the placement line. We recommend cutting slightly outside of the cutting line. Do not cut inside the cutting line, otherwise the appliqué fabric will not be caught by the appliqué stitch.
- When using patterns that are vertically and horizontally symmetrical, use a chalk pencil to indicate the pattern orientation before cutting it out.

- 10 Use two layers of adhesive water soluble stabilizer material with their sticky sides together, and then hoop them in the embroidery frame.

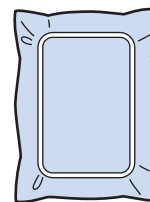

Note

- If water soluble stabilizer is used, it is not necessary to remove the stabilizer material after sewing the appliqué outline. To reduce shrinkage of the pattern, we recommend using water soluble stabilizer.
- Put together two layers of water soluble stabilizer, otherwise the stabilizer material may tear during embroidering.

- 11 Thread the machine with the thread for the outline, and then sew the placement line for the appliqué position (APPLIQUE POSITION).

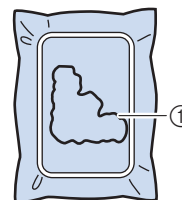

① Pattern placement line

- 12 Use two-sided stabilizer material, and paste the appliqué piece so that it aligns with the placement line.

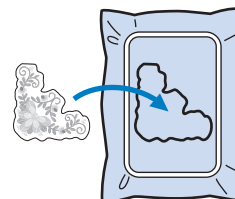

- 13 With the machine threaded using the thread for the outline from step 11, embroider the outline (APPLIQUE).

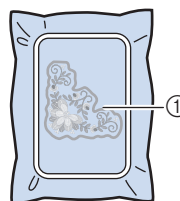

① Outline of appliqué piece

- 14 After embroidering is finished, remove the stabilizer material from the embroidery frame.

Note

- Since glue may become attached to the presser foot, needle or needle plate, clean off any glue after finishing embroidering the appliqué pattern.

- 15 Use scissors to cut the excess water soluble stabilizer from outside the appliqué outline.
- 16 Soak the appliqué piece in water to dissolve the water soluble stabilizer.

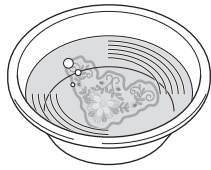

- 17 Dry the appliqué piece, and then iron it if necessary.

Note

- Do not apply a strong force when ironing, otherwise the stitching may be damaged.

MAKING EMBROIDERY ADJUSTMENTS

Adjusting Thread Tension

When embroidering, the thread tension should be set so that the upper thread can slightly be seen on the wrong side of the fabric.

The following screen appears when you press .

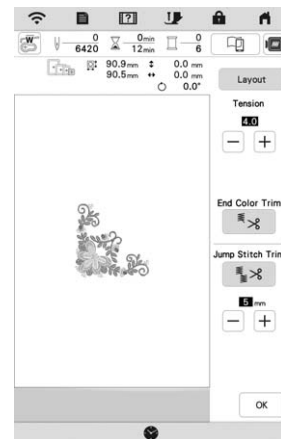
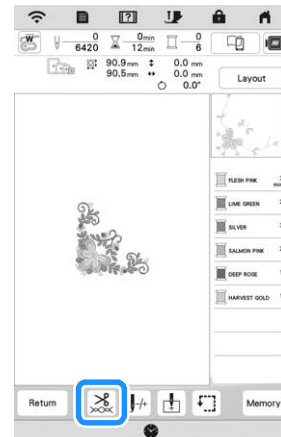

Correct Thread Tension

The pattern can be seen from the wrong side of the fabric. If the thread tension is not set correctly, the pattern will not finish well. The fabric may pucker or the thread may break.

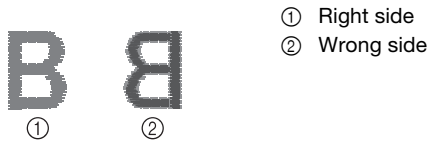

Follow the operations described below to adjust thread tension according to the situation.

Note

- If the thread tension setting is made extremely weak, the machine may stop during embroidering. This is not the sign of a malfunction. Increase the thread tension slightly, and start embroidering again.

Memo

- If you turn the main power to OFF or select a different pattern, the thread tension will reset to the automatic setting.

Upper Thread Is Too Tight

The tension of the upper thread is too tight, resulting in the bobbin thread being visible from the right side of the fabric.

Note

- If the bobbin thread was incorrectly threaded, the upper thread may be too tight. In this case, refer to “Setting the Bobbin” on page 26 and rethread the bobbin thread.



Press **-** in **Tension** to weaken the upper thread tension. (The tension number will decrease.)

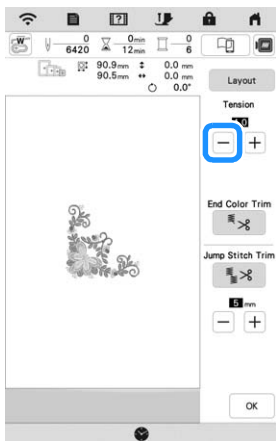

Upper Thread Is Too Loose

The tension of the upper thread is too loose, resulting in a loose upper thread, loose thread locks, or loops appearing on the right side of the fabric.

Note

- If the upper thread was incorrectly threaded, the upper thread may be too loose. In this case, refer to “Upper Threading” on page 28 and rethread the upper thread.

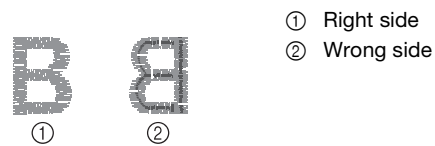

Press **+** in **Tension** to tighten the upper thread tension. (The tension number will increase.)

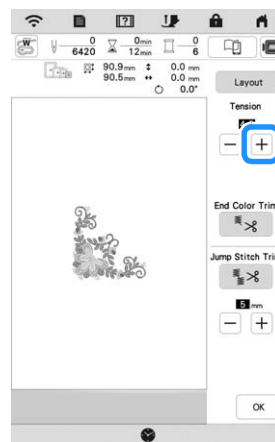

Adjusting Overall Upper Thread Tension

When embroidering, if the overall tension of the upper thread is too tight or too loose, adjust it from the setting screen. The selected setting will be applied to all patterns. If an individual embroidery pattern needs additional fine tuning, refer to “Adjusting Thread Tension” on page 73.

- 1 Press **[Menu]**.
→ The settings screen appears.
- 2 Press **[Embroidery]**.
→ The embroidery settings screen appears.
- 3 Display **[Embroidery Tension]** in the embroidery settings screen.
- 4 Use **+** **-** to adjust the upper thread tension.
* **+** : Tighten the upper thread tension.
* **-** : Loosen the upper thread tension.
- 5 Press **[OK]**.



Adjusting the Bobbin Case (with No Color on the Screw)

The bobbin case (with no color on the screw) can be easily adjusted when bobbin tension changes are required to accommodate different bobbin threads. Refer to "Embroidering Attractive Finishes" on page 62.

To adjust the bobbin tension for embroidery function, using the bobbin case (with no color on the screw), turn the slotted screw (-) with a (small) screwdriver.

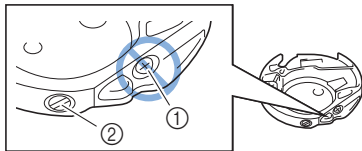

- ① Do not turn a phillips screw (+).
- ② Adjust with a screwdriver (small).

■ Correct Tension

Upper thread slightly appears on the wrong side of fabric.



- ① Right side
- ② Wrong side

■ Bobbin Thread Is Too Loose

Bobbin thread appears slightly on the right side of fabric.

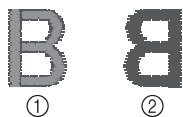

- ① Right side
- ② Wrong side

If this occurs, turn the slotted screw (-) clockwise, being careful not to over-tighten the screw, approximately 30-45 degrees to increase bobbin tension.

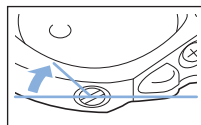

■ Bobbin Thread Is Too Tight

Upper thread on the right side of fabric seems to be lifting/looping and bobbin thread is not seen on the wrong side of fabric.

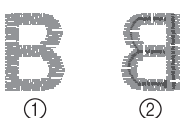

- ① Right side
- ② Wrong side

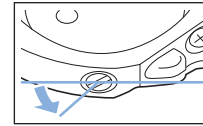

If this occurs, turn the slotted screw (-) counterclockwise, being careful not to over-loosen the screw, approximately 30-45 degrees to decrease bobbin tension.



⚠ CAUTION

- When adjusting the bobbin case, be sure to remove the bobbin from the bobbin case.
- DO NOT adjust the position of the phillips (+) screw on the bobbin case as this may result in damage to the bobbin case, rendering it unusable.
- If the slotted screw (-) is difficult to turn, do not use force. Turning the screw too much or providing force in either (rotational) direction may cause damage to the bobbin case. Should damage occur, the bobbin case may not maintain proper tension.

Using the Automatic Thread Cutting Function (End Color Trim)

The automatic thread cutting function  will cut the thread at the end of embroidering each color. This function is initially turned ON. To turn this function OFF, press  and then .

* This setting returns to its default  when the machine is turned off.

1 Press .

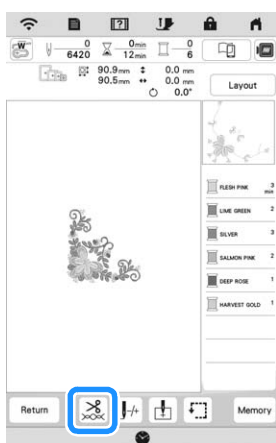

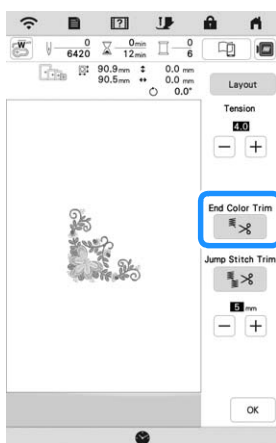

2 Press  to turn off the automatic thread cutting function.



→ The key will display as . When one color thread is embroidered, the machine will stop without cutting the thread.

Using the Thread Trimming Function (Jump Stitch Trim)

The thread trimming function  will automatically trim any excess thread jumps within the color. This function is initially turned ON. To turn this function OFF, press  key and then .

* Your customized setting remains after turning the machine off and on.

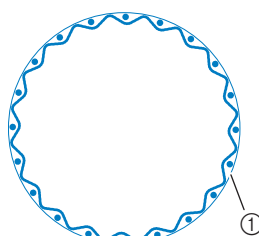

① Jump stitch

ABCDEF

①

1 Press .

2 Press  to turn off the thread trimming function.

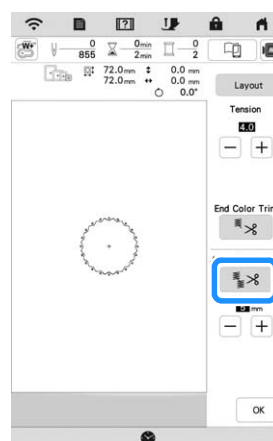

→ The key will display as . The machine will not trim the thread before moving to the next stitching.

■ Selecting the Length Of Jump Stitch Not to Trim

When the thread trimming function  is turned on, you can select the length of the jump stitch. Select a setting from 5 mm to 50 mm in 5 mm increments.

* Your customized setting remains after turning the machine off and on.

Press  or  to select the length of jump stitch.

For example: Press **+** to select 25 mm (1 inch) and the machine will not trim a jump stitch of 25 mm or less before moving to the next stitching.

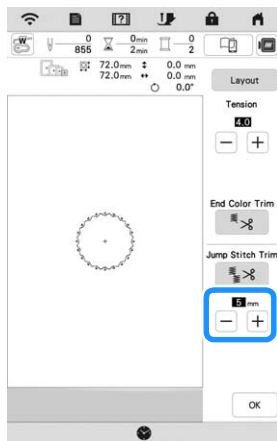

Note

- If design has many trims it is recommended to select a higher jump stitch trim setting in order to reduce the amount of excess tails on backside of fabric.
- The higher number of the jump stitch length selected, the fewer number of times the machine will trim. In this case, more jump stitches remain on the surface of the fabric.

Adjusting the Embroidery Speed

- 1 Press .
→ The settings screen appears.
- 2 Press .
→ The embroidery settings screen appears.
- 3 Display [Max Embroidery Speed] in the embroidery settings screen.
- 4 Use **+** **-** to change the maximum embroidery speed.



Memo

- SPM is the number of stitches embroidered in one minute.
- Decrease the embroidery speed when embroidering on thin, thick, or heavy fabrics and when using a speciality thread like a metallic thread.
- The setting specified before the main power is set to OFF remains selected the next time that the machine is turned ON.

Changing the Thread Color Display

You can display the name of the thread colors or embroidery thread number.

Memo

- Colors on the screen may vary slightly from actual spool colors.
- [Original], imported data remains the brand thread created with the software, is set as a default.

- 1 Press .
→ The settings screen appears.
- 2 Press .
→ The embroidery settings screen appears.
- 3 Display [Thread Color] in the embroidery settings screen.
- 4 Use to display the name of the thread colors or the embroidery thread number.

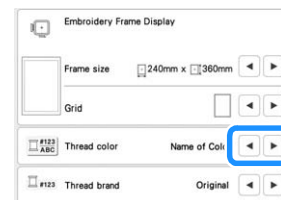

- 5 Use to select a thread brand.



Aligning the Pattern and the Needle

Example: Aligning the lower left side of a pattern and the needle

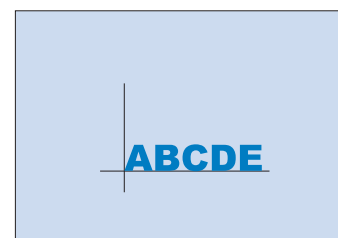

- 1 Mark the embroidery start position on the fabric, as shown.

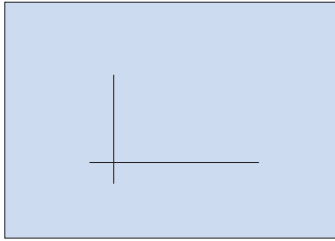

- 2 Press .

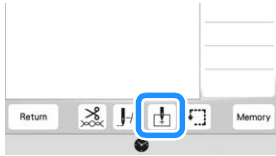

- 3 Press .

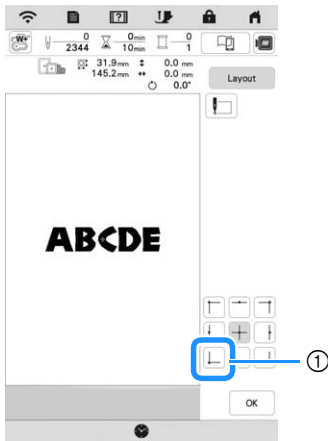

- 1 Start position
→ The needle is positioned in the lower-left corner of the pattern. The carriage moves so that the needle is positioned correctly.

- 4 Press .

- 5 Press  and then, press .

- 6 Use  to align the needle and the mark on the fabric, and start embroidering the pattern.

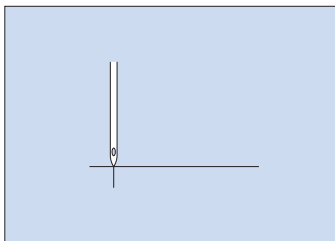

Embroidering Linked Characters

Follow the procedure described below to embroider linked characters in a single row when the entire pattern extends beyond the embroidery frame.

Example: Linking "FG" to the characters "ABCDE"

A B C D E F G

- 1 Select the character patterns for "ABCDE".

- 2 Press .



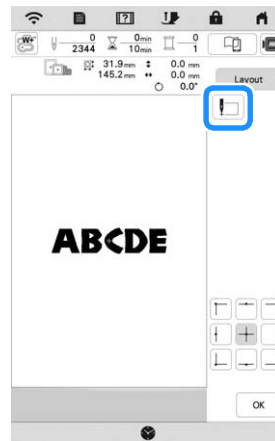

- 3 Press .



- The needle is positioned in the lower-left corner of the pattern. The carriage moves so that the needle is positioned correctly. The machine is set to embroider until the first stitch of the next character pattern (F).

Note

- To cancel the starting point setting and return the starting point to the center of the pattern, press  or .
- Using  can select a different starting point for embroidering. However, the starting point setting is canceled.

- 4 Press .

5 Press .



6 Press  to turn off the thread cutting function and then press .

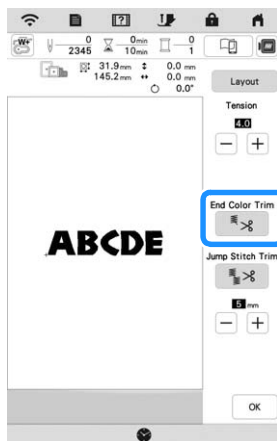

7 Start embroidering.

8 After the characters are embroidered, cut the threads to a generous length, remove the embroidery frame, reposition the fabric in the hoop so that the remaining characters ("FG") can be embroidered, and then attach the embroidery frame.

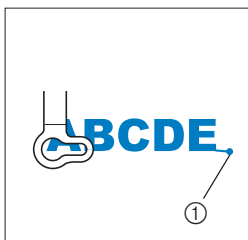

① End of the embroidering

9 As in step 1, select the character patterns for "FG".

10 Press .

11 Press .

→ The needle is positioned in the lower-left corner of the pattern. The carriage moves so that the needle is positioned correctly.

12 Press , then and use  to align the needle with the end of embroidering for the previous pattern.

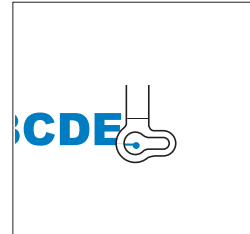

13 Press .

14 Press the "Start/Stop" button to start embroidering the remaining character patterns.



USING THE MEMORY FUNCTION

Saving Embroidery Patterns

Note

- Do not turn the main power to OFF while the [Saving...] screen is displayed. You will lose the pattern you are saving.
- Embroidery patterns cannot be transferred if the computer and machine are connected to different home networks. Be sure to connect to the same home network.

1 Press **Memory** when the pattern you want to save is in the embroidering screen.

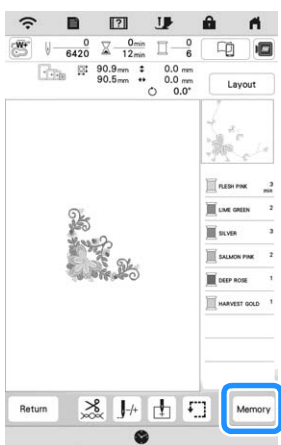

2 Press the desired destination to start saving.



- 1 Save to the machine's memory.
- 2 Save to the USB media. The pattern is saved in a folder labeled [bPocket]. When saving the embroidery pattern in a USB media, insert the USB media into the USB port on the machine.

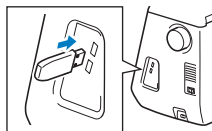

- 3 Save the pattern via the wireless network connection. For detailed procedures, refer to PE-DESIGN manual (Version 11 or higher).

Retrieving Embroidery Patterns

1 Press the desired destination, and then select the desired embroidery pattern.

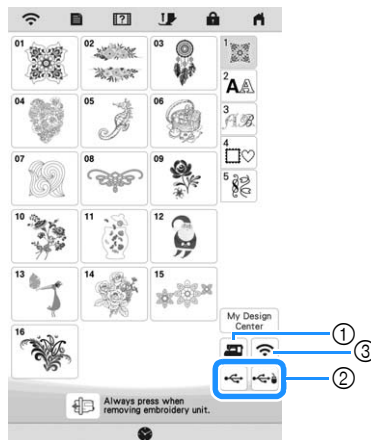

- 1 Retrieve from the machine's memory.
- 2 Retrieve from a USB media. When retrieving the embroidery patterns from a USB media, insert the USB media into the USB port on the machine.
- 3 Retrieve the pattern via the wireless network connection. For detailed procedures, refer to PE-DESIGN manual (Version 11 or higher).

Memo

- If the embroidery pattern to be retrieved is in a folder of the USB media, press the key for that folder. Press **Return** to return to the previous screen.
- You can save all or multiple data to the machine by pressing **Select all**.

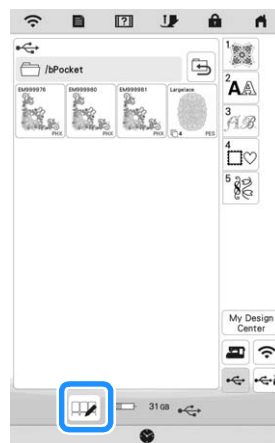

- To select multiple patterns, press their thumbnails.
 - **Select all** : Select all patterns.
 - **Select none** : Deselect all patterns.
 - **Memory** : Save the selected patterns to the machine.
- * To cancel the selection, press **Select all** again.

2 Press **Set**.

- * Press **Delete** to delete the embroidery pattern.

EMBROIDERY APPLICATIONS

Using a Frame Pattern To Make an Appliqué

Note

- If you change the size or position of the patterns when making an appliqué, make a note of the size and the location.

Method 1

You can use framed patterns of the same size and shape to create an appliqué. Embroider one pattern with a straight stitch and one pattern with a satin stitch.

- 1 Select a straight stitch frame pattern. Embroider the pattern onto the fabric for the appliqué piece, then cut neatly around the outside of the shape.

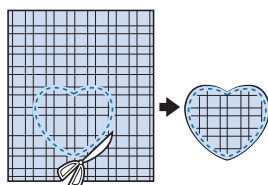
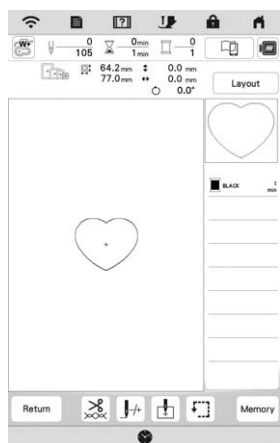

- 2 Embroider the same pattern from step 1 onto the base fabric.
- 3 Apply two-sided stabilizer material to the back of the fabric for the appliqué piece created in step 1. Attach the appliqué to the base fabric matching the shapes.

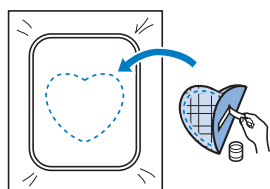

- 4 Select the satin stitch frame pattern of the same shape as the appliqué. Embroider over the fabric for the appliqué piece and base fabric from step 3 to create the appliqué.

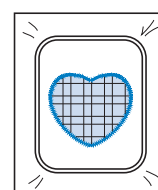
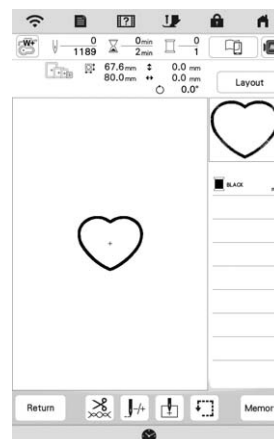
**Method 2**

- 1 Select a straight stitch frame pattern, and embroider the pattern onto the base fabric.

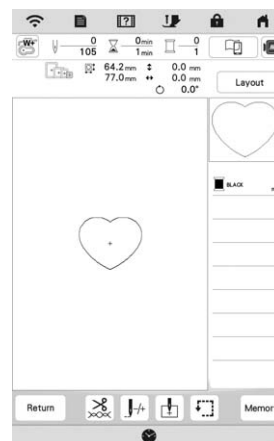

- 2 Place the fabric for the appliqué piece over the pattern embroidered in step 1 and embroider the same pattern on the fabric for the appliqué piece.

* Be sure that the fabric for the appliqué piece completely covers the stitched line.

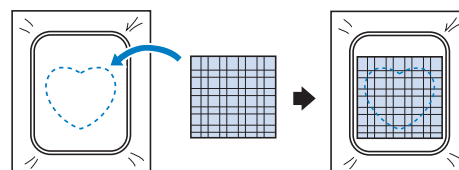

- Remove the embroidery frame from the embroidery unit, and cut around the outside of the stitches of the fabric for the appliqué piece. And then, reattach the embroidery frame to the embroidery unit.

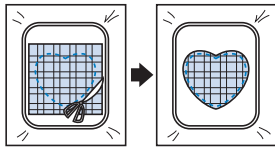

Note

- Do not remove the fabric from the embroidery frame to cut it. Also, do not pull or push on the fabric. Otherwise, the fabric may loosen in the frame.

- Select the satin stitch frame pattern of the same shape as the appliqué and embroider the satin stitch pattern to create an appliqué.

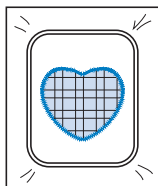
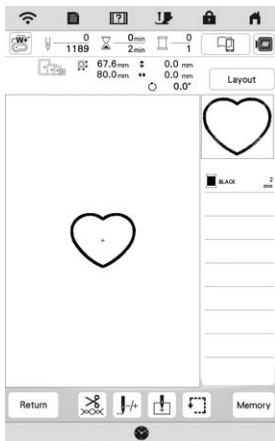

Embroidering Split Embroidery Patterns

Split embroidery patterns created with PE-DESIGN Ver. 7 or later, or PE-DESIGN NEXT can be embroidered. With split embroidery patterns, embroidery patterns larger than the embroidery frame are divided into multiple sections, which combine to create a single pattern after each section is embroidered.

For details on creating split embroidery patterns and for more detailed embroidery instructions, refer to the Instruction manual included with PE-DESIGN Ver. 7 or later, or PE-DESIGN NEXT.

- Insert the USB media containing the created split embroidery pattern, and then select the split embroidery pattern to be embroidered. (page 80)

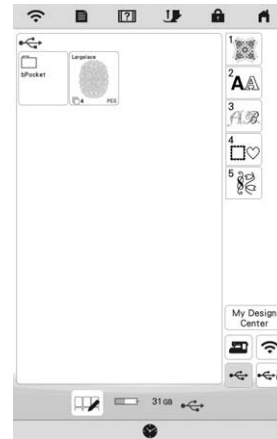

- Select section 001 to be embroidered.

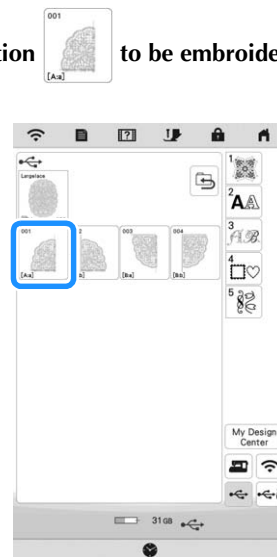

- Press **Set**.

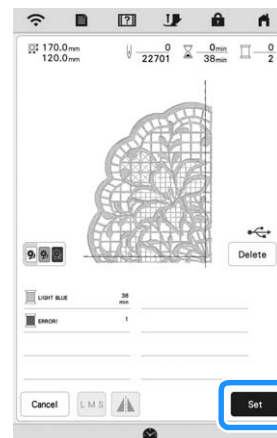

- 4 If necessary, press and edit the pattern.

Press to display the embroidery screen.



- 5 Embroider the pattern section.

- 6 When embroidering is finished, the following screen appears. Press .



→ A screen appears so that a section of the split embroidery pattern can be selected.

- 7 Repeat steps 2 through 6 to embroider the remaining sections of the pattern.



Chapter **4**
My Design Center



ABOUT MY DESIGN CENTER

With My Design Center, you can use the functions listed below:

- Hand-drawn functions - creating embroidery patterns by drawing on the LCD screen
- Loading functions - creating embroidery patterns by transferring data from the application or USB media.

You can also combine patterns that you have created with the machine's built-in patterns.

Start My Design Center by pressing  in the home

page screen or pressing  in the embroidery pattern selection screen.

PATTERN DRAWING SCREEN

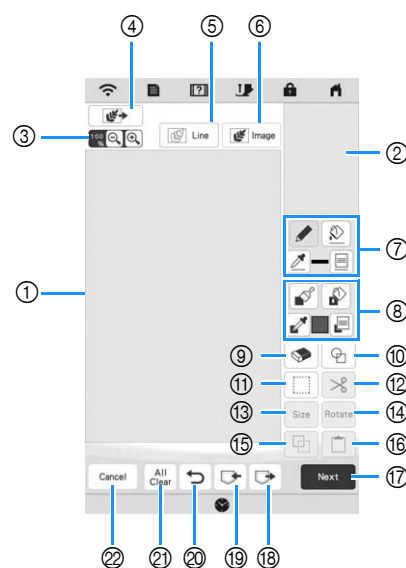

- ① Pattern drawing area
- ② Pattern preview area

Memo

- The actual dimension of the pattern area is the size of the embroidery frame, which is shown in the pattern preview area. The pattern you drew may be bigger than you expected. Please resize the pattern after converting the design to the embroidery pattern.
- When the pattern is enlarged so that only a part of it appears in the pattern drawing area, the entire pattern is displayed in the pattern preview area. The red frame in the pattern preview area indicates the part of the pattern displayed in the pattern drawing area. Move the red frame in the pattern preview area with the touch pen (stylus) or your finger to display the corresponding area in the pattern drawing area.

■ Key Functions



No.	Display	Explanation	Page
	Name		
③		Magnify the pattern.	89
	Magnify key		
④		Load the fabric as the background or the picture as the reference when creating the pattern. You can load the image file from the application or USB media.	94
	Load key		
⑤		Load a line drawing, then edit and convert it to embroidery data. You can load a line drawing from the application or USB media to create the embroidery design.	95
	Line design key		
⑥		Load an image, then edit and convert it to embroidery data. You can load an image from the application or USB media to create the embroidery design.	97
	Image design key		
⑦		Draw lines and set the color. You can select the line type, stitch type and color as you need. Press to pick up the color, line type and stitch type from a line in the pattern within the pattern drawing area. The picked up color is shown as the currently selected line color beside the button and as the selected color in the Line Property screen.	88
	Line tool key		
⑧		Paint with brush and set the color. You can select the brush type, fill type and color as you need. Painted lines and regions will be converted to the pattern to be embroidered with fill stitch. Press to pick up the color, brush type and fill type from a region in the pattern within the pattern drawing area. The picked up color is shown as the currently selected region color beside the button and as the selected color in the Region Property screen.	89
	Brush tool key		
⑨		Erase lines and shapes that have been drawn. You can select the size/shape of the eraser.	91
	Erase key		
⑩		Select the stamp shape for pattern drawing.	90
	Stamp key		
⑪		Select a section for moving by finger or pen, copying, deleting, changing size and rotating lines and shapes that have been drawn.	91
	Select key		
⑫		Cut out the selected section.	—
	Cut key		
⑬		Change the size of the selected section.	99
	Size key		
⑭		Rotate the selected section.	—
	Rotate key		

No.	Display	Explanation	Page
	Name		
⑮		Duplicate the selected section. The temporarily positioned section can immediately be rotated, enlarged, reduced or moved.	—
	Duplicate key		
⑯		Paste in the pattern drawing area a selected section duplicated with the duplicate key or a selected section using the cut key.	—
	Paste key		
⑰		Proceed to the stitch settings screen.	—
	Next key		
⑱		Recall image data created with My Design Center from the machine's memory or the USB media.	—
	Recall key		
⑲		Store the pattern being created to the machine's memory or the USB media.	—
	Memory key		
⑳		Undo the last operation that was performed and return to the previous state. Each press of this key will undo one operation.	—
	Undo key		
㉑		Clear all the lines and shapes and start from the beginning. The background image is also cleared.	—
	All Clear key		
㉒		Exit from My Design Center. All lines and shaped are erased when you press this key.	—
	Cancel key		

Before Creating Designs

The pattern preview displays the design smaller than the actual size. You can view the actual pattern size by setting the [Embroidery Frame Display].

With [Embroidery Frame Display] in the settings screen, the embroidery frame and grid can be specified separately.

- 1 Press  .
→ The settings screen appears.
- 2 Press  .
→ The embroidery settings screen appears.
- 3 Display [Embroidery Frame Display] in the embroidery settings screen.
- 4 Select the embroidery frame display.

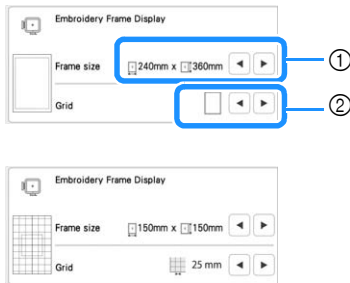

- ① Embroidery frame types
- ② Grid types

Drawing Lines

- 1 Press  and draw lines.

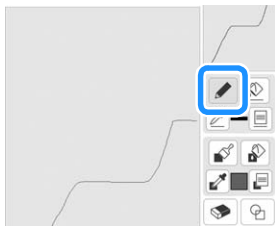

Memo

- When  is pressed, all regions will be displayed in the background to clarify the drawing lines on the screen.

Setting the Line Types, Stitch Types and Colors

You can set or change the line types, stitch types and colors anytime. You can also specify the line types, stitch types and colors before drawing lines.

- 1 Press  to set the line types, stitch types and colors.

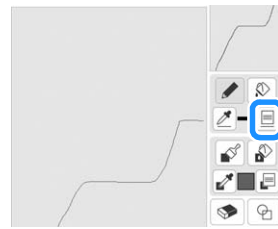



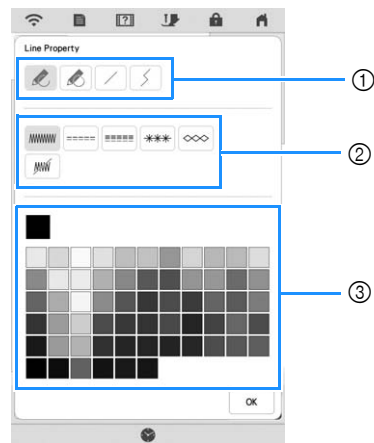

→ The settings screen appears.









- ① Line types
- ② Stitch types
- ③ Line color selection: touch the color palette to activate the drawing pen color.

Line types

	Freehand line with the end open.
	Freehand line closing the end automatically.
	Straight line with one stroke
	Straight line changing directions to the point you select. If the end point is created near the start point, a closed object will be created.

Stitch types

	Zigzag stitch
	Running stitch
	Triple stitch
	Candlewicking stitch
	Chain stitch
	Line without stitch for creating a region. Created region will be defined by the gray line.

2 Press  to return to the pattern drawing screen.

→ The color bar on the line tool key is changed to the selected color.

* The appearance of the line does not change even if the line type was changed. The specified line type can be checked in the stitch settings screen.

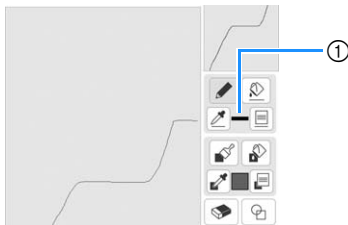



① Color bar

3 Press  then press on the line to change its color.

→ The connected line will be changed to the selected color.

Memo

- Press  to magnify the image when you cannot press on the line correctly.
- Press , and then select a color within the pattern drawing area to apply the same color to other lines or parts of the pattern.

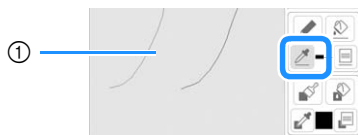

① Use  to select the line color.



② Press  for changing the line color, and then select the pattern to be changed.

Drawing Regions

1 Press  and draw with brush.





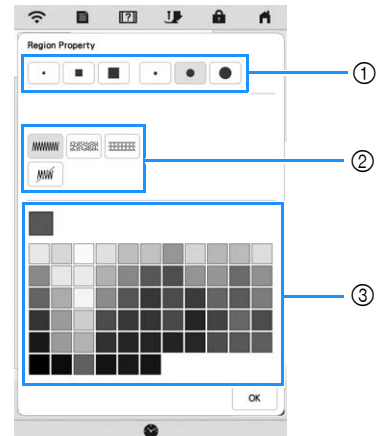

Setting the Brush Types and Fill Colors







1 Press  to set the brush types and fill colors.







- ① Brush types
- ② Fill stitch types
- ③ Fill color selection: touch the color palette to activate the paint brush color.

Brush shapes/sizes

	Square brush	
	Round brush	

	Small brush	
	Medium brush	
	Large brush	

Fill stitch types

	Fill stitch
	Stippling stitch
	Decorative fill stitches Displays a stitch selection screen, where  can be pressed to select a stitch.



Select  when you don't want fill stitch.

2 Press to return to the pattern drawing screen.

→ The color bar on the brush tool key is changed to the selected color. If a stippling stitch or decorative fill stitch has been selected, the stitch is displayed.

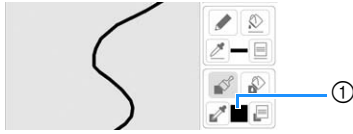

① Color bar

3 Press and press on the brush line to change color and fill stitch type. You can also set the color and fill stitch type of a closed region made of the line.

Memo

- Press to magnify the image when you cannot press on the fill correctly.
- Press , and then select a pattern color in the pattern drawing area to apply that fill color to other patterns.

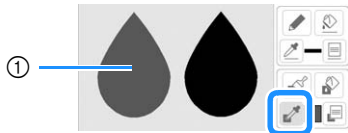

① Use to select the fill color.

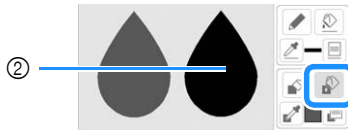

② Press for changing the fill color, and then select the pattern to be changed.

Using the Stamp Key

1 Press .



2 Select a stamp type and stamp shape.

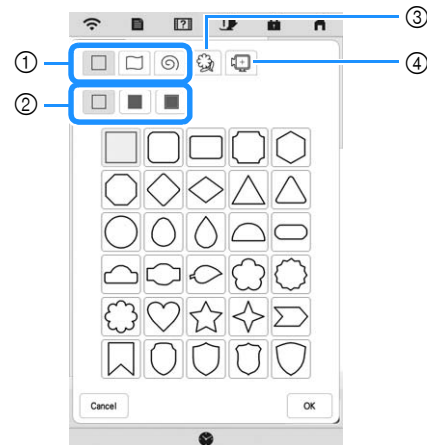

- ① Stamp shapes
- ② Stamp types
- ③ Saved outlines
- ④ Frame embroidering areas

Stamp shapes

	Basic shapes
	Closed shapes
	Open shapes

Stamp types (Only for Basic shapes)

	Outline
	Fill stitch
	Outline and fill stitch

* Select the outline () , fill stitch () , or outline and fill stitch () of a basic shape.

Saved outlines

 Embroidery pattern outlines can be registered as stamp shapes. When registering stamp shapes, select from the last six embroidery patterns used. If more than six shapes are registered, the oldest one is automatically erased. For details on registering a stamp shape, refer to “Decorative Stitching around a Pattern in Embroidery (a Quilting Function)” on page 101.

Frame embroidering areas

 Select an embroidering area in order to arrange the pattern to fit an embroidery frame.

* Press to return to the pattern drawing screen.

3 Press to set the selected stamp.

→ The pattern drawing screen appears.

* You can change size of, rotate or move the shape right after you create it by pressing or .

Using the Erase Key

1 Press .

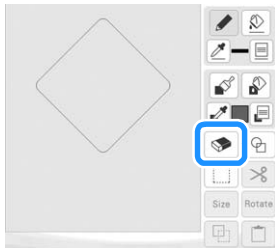

2 Select the shape of the eraser.



→ The pattern drawing screen appears.

3 Drag along the area or line that you want to erase while the key appears as .

Using the Select Key

You can select the part of the design to move and/or edit. Some keys are available only after you select the part.

1 Press .

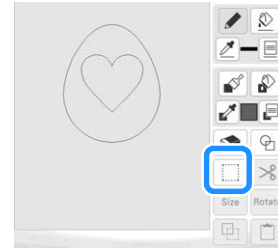

2 Select the area you want to edit.

* To select an area you want to edit, hold the touch pen (stylus) at a point on the screen and drag the touch pen (stylus) to create the red box around your selected area to be edited.

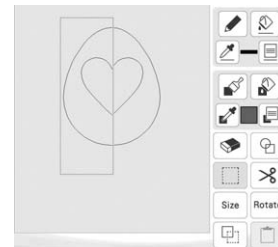

3 Edit the design with available keys. (Refer to “Key Functions” on page 87 for the details of each key function.)

4 Press , and then specify the stitch setting.

STITCH SETTINGS SCREEN

Before creating the embroidery pattern, specify the stitch settings. Lines of the design are embroidered with various stitches and regions are embroidered with fill stitches or stippling stitches. Stitching of the regions was already selected in "Drawing Regions" on page 89, so specify values of detailed settings.

After specifying the settings, press to create the embroidery pattern.

Specifying Individual Stitch Settings

Select a pattern in the stitch settings screen to specify its line and region stitch settings. If multiple patterns are selected, the settings are applied to those patterns.

Line Settings

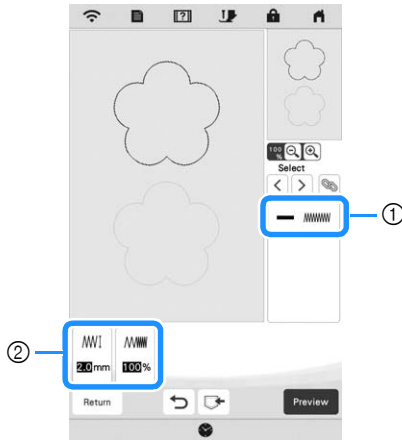

- ① Shows the stitch type and color for the selected line.
- ② Shows the stitch settings for the selected line.

Line stitch settings

Select the type of stitching you want applied to your line art, from zigzag stitch (), running stitch (), triple stitch (), candlewicking stitch () or chain stitch ().

Zigzag stitch

Zigzag width	Specifies the width of the stitch.
Density	Specifies the density of the stitch.

Running stitch /Triple stitch

* Both includes an under sewing.

Run pitch	Specifies the length of the stitch.
-----------	-------------------------------------

Candlewicking Stitch

Size	Increases/reduces the size of the stitch.
Spacing	Specifies the spacing of the stitch.

Chain stitch

Size	Increases/reduces the size of the stitch.
Repetition	Sets repeated embroidering at the same part.

Region Settings

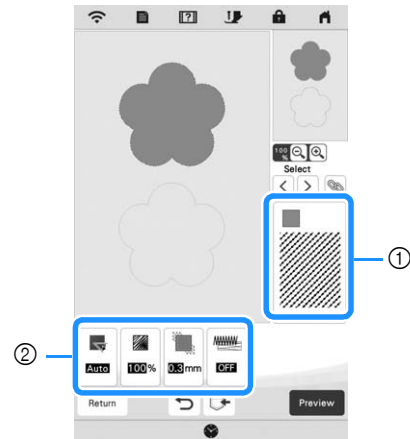

- ① Shows the stitch type and color for the selected region.
- ② Shows the stitch settings for the selected region.

Fill stitch settings

Direction	Specifies the embroidering direction. Select <input type="button" value="Manual"/> to change to the desired direction of fill stitch.
Density	Specifies the stitch density of fill stitch.
Pull compensation	Specifies to correct the shrinkage of the pattern by slightly shortening or lengthening the stitching. Change the setting after you embroider the pattern and can check the shrinkage.
Under sewing	Select if you need or do not need the under sewing for the stabilized fabric.

Stippling stitch settings

Run pitch	Specifies the length of a stitch of the stippling stitch.
Spacing	Specifies the spacing between the stitches when embroidering the stippling stitch.
Distance	Specifies the offset from the pattern outline.

Decorative fill stitch settings

Size	Increases/reduces the size of the pattern.
Direction	Specifies the rotation angle of the pattern.
Outline	Select whether [ON] or [OFF] the outline is also converted to embroidery data. If [ON] is selected, the number of thread jumps can be reduced.

1 Use to select the line or region to be changed.

→ Each press of moves the highlighting of the selected pattern in order.

2 Select the setting to be changed, and then change the setting in the screen that appears. (In this example, the embroidering direction will be changed.)



→ The setting screen appears.

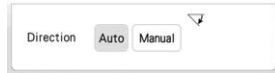

3 Press , and then use to change the direction.



4 Press to apply the setting.

- * appears on the tab for settings that were changed.
- * Change other settings in the same way.

Specifying Global Stitch Settings

The same stitch settings can be changed at the same time for multiple patterns of the same type.

1 Use to select the stitch whose settings are to be changed, and then press .

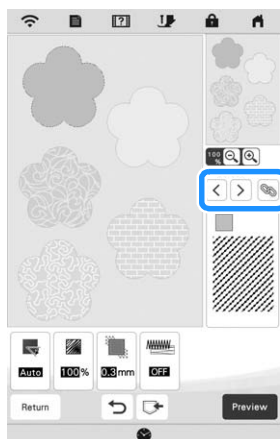

→ The same stitch type lines or regions will be selected at the same time.



2 Follow steps 2 through 4 in “Specifying Individual Stitch Settings” on page 92 to change the settings.

3 Press to create the embroidery pattern.

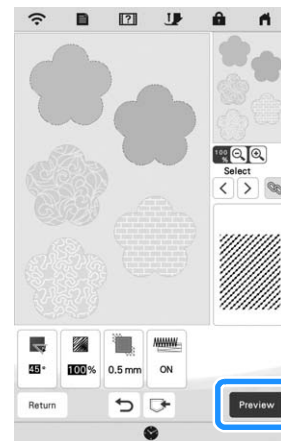

→ When the following message appears, press .

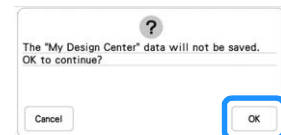

4 Press **Set** to display the pattern editing screen.

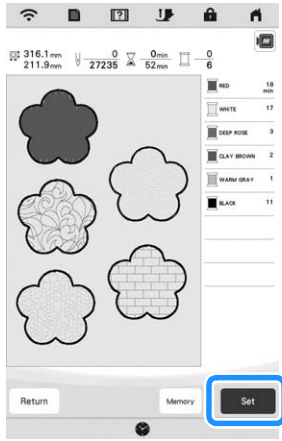

→ When the following message appears, press **OK**.

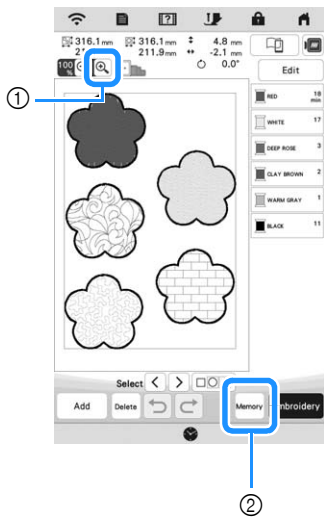
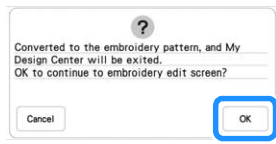

- ① : Check an enlarged view of the pattern.
- ② **Memory** : Save the embroidery data.

Loading the Background Image

Prepare the data file of your favorite picture so that you can create an embroidery pattern. Load the image file from the application or a USB media.

1 Press .



2 Select the device you saved the data to.



3 Select the data, and then press **Set**.



4 The selected image is displayed transparently in the pattern drawing area.





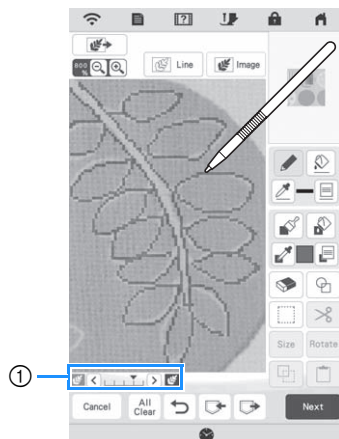

- 5 Using the included touch pen (stylus), press , and then draw lines to trace the image.

* For details on drawing lines, refer to “Drawing Lines” on page 88.



- ① Transparency adjustment

* Press  or  to adjust the transparency of the background.

Each press of  lightens the background, making the line pattern darker. Each press of  darkens the background, making the line pattern lighter.

- 6 After editing the pattern, press  to specify the settings for pattern.

- 7 Press  to create the embroidery pattern.

LINE CONVERSION

Custom patterns can be created from drawings. You can create patterns by loading an image on the application or a USB media.

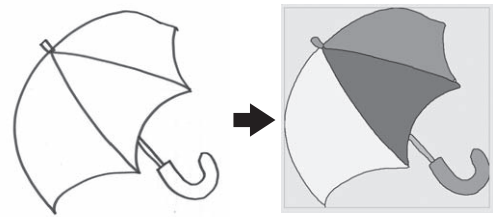

Recommended line drawings for Line Conversion

- Line drawings must be drawn clearly using lines with approximately 1 mm thickness.
- Line drawings should be drawn in a strong contrast.
- If the lines are too short or gathered too densely, they will not be loaded correctly.

Note

- For details on creating patterns using color illustrations, refer to “ILLUSTRATION CONVERSION” on page 97.
- If you cannot convert the drawings as expected, you can edit the design in My Design Center. Refer to “PATTERN DRAWING SCREEN” on page 86.
- Line drawings are converted without recognizing the thickness of lines. If you want to change the thickness of lines, specify in the settings screen. Refer to “STITCH SETTINGS SCREEN” on page 92.
- Line drawings are converted as black lines. If you want to change the colors, specify in My Design Center. Refer to “Drawing Lines” on page 88.

Create a Pattern with Line Conversion

- 1 Press  .

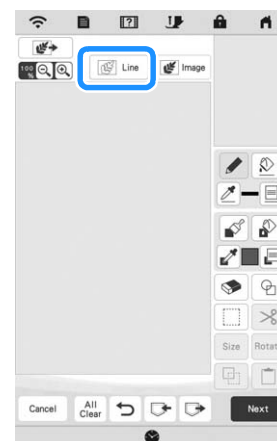

→ The image display screen appears.

2 Select the device you saved the data to.



3 Select the data, and then press **Set**.

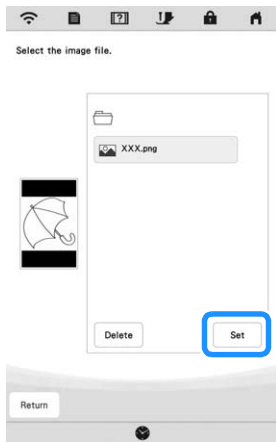

4 When loading is finished, specify the [Gray-Scale Detection level] on the screen if necessary.

The [Gray-Scale Detection level] can change the black and white threshold for the image.



- * If you do not know how the settings should be changed, first continue the operation without specifying settings and check the results.
- * To stop loading and return to the screen in step **2**, press **Cancel**. The loaded image will be deleted when you return to the previous screen.

5 Move  to frame the image for the pattern.

6 Press **OK**.

→ The screen for confirming the converted image appears.

7 In the screen for confirming the converted image, you can adjust the [Gray-Scale Detection level] again, if necessary.

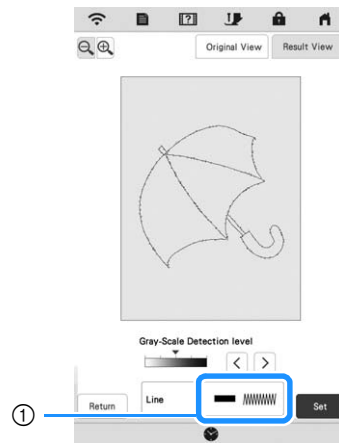

① The settings for the lines to be embroidered appear.

- * If you do not know how the settings should be changed, first continue the operation without specifying settings and check the results.
- *  : Enlarge the image.
- * **Original View** : Display the image before being converted. Compare the images before and after being converted, and then change the settings if necessary.
- * **Return** : Return to the previous screen.

→ After changes to the settings for [Gray-Scale Detection level] are applied, **Set** changes to **Retry**. Press **Retry** to check that the image is as desired.

8 Press **Set**.

→ The pattern drawing screen appears.

9 If necessary, edit the loaded image.

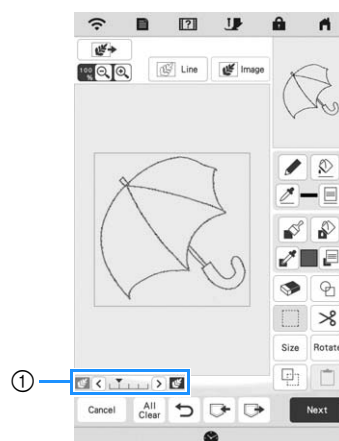



- * After the loaded image is converted to stitching, it appears as a background in the pattern drawing screen. Use gauge ① to adjust the transparency of the background. Each press of  lightens the background, making the line pattern darker. Each press of  darkens the background, making the line pattern lighter.

ILLUSTRATION CONVERSION

Custom patterns can be created from color illustrations. You can create patterns by loading an image on the application or a USB media.

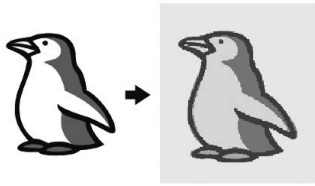

Recommended illustrations for Illustration Conversion

- Illustrations that are clearly drawn, with no gradation, fading or blurriness.
- Illustrations that are at least a 5 mm square
- Illustrations that are extremely simple images

Create a Pattern with Illustration Conversion

1 Press Image .

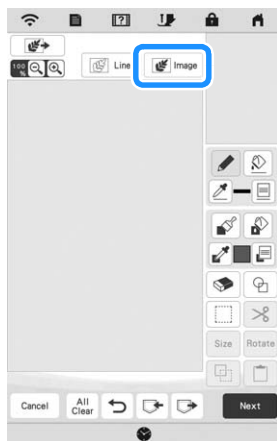

→ The image display screen appears.

2 Select the device you saved the data to.



3 Select the data, and then press .



4 When loading is finished, specify the necessary settings in the loaded image confirmation screen.

Change the settings to adjust the image so it can easily be converted to the desired pattern.

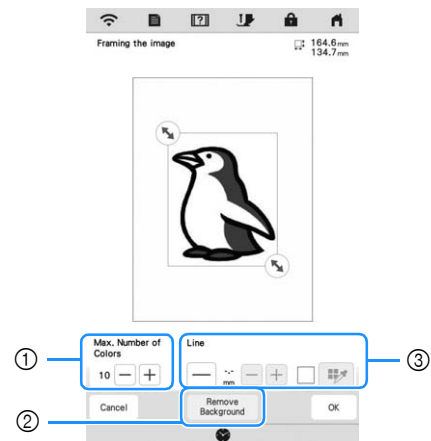

①	[Max. Number of Colors]	The number of colors in an image will be reduced less than the number specified here, and then the outline will be extracted.
②	[Remove Background]	Select whether or not the background color will be included as one of the colors.
③	[Line]	Select whether or not the outline will be detected as a line. A thick outline can also be detected as a region. When detected as a line, the line thickness and color can be specified.

* To stop loading and return to the screen in step 2, press .

Memo

- Press to detect the outline. Line thickness can be specified from 1.0 mm (1/16 inch) to 5.0 mm (3/16 inch).



- Press to select the outline color. Select by touching the color, or moving icon using



in the color selection screen.

5 Move to frame the image for the pattern.

6 Press .

→ The screen for confirming the converted image appears.

7 In the screen for confirming the converted image, adjust the image as necessary as in step 4.



- * : Enlarge the image.
 - * : Display the image before being converted. Compare the images before and after being converted, and then change the settings if necessary.
 - * : Return to the previous screen.
- After changes to the settings described above have been applied, changes to . Press to check that the image is as desired.

8 Press .

→ The pattern drawing screen appears.

9 If necessary, edit the loaded image.

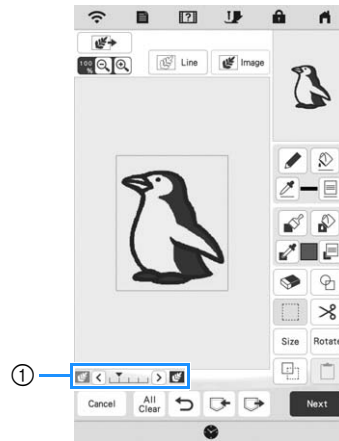

- * After the loaded image is converted to stitching, it appears as a background in the pattern drawing screen. Use gauge ① to adjust the transparency of the background. Each press of lightens the background, making the illustration pattern darker. Each press of darkens the background, making the illustration pattern lighter.

STIPLING

Basic Stipling with My Design Center

Create a stipling design with the basic procedure.

Example:

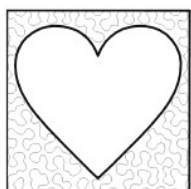

Note

- You can load a line drawing to create a stipling stitch or use image design function of a fabric pattern and incorporate the stipling stitch.

1 Press  .

* You can also start the function by pressing  in the embroidery pattern selection screen.

2 Press  .



3 Select the square shape, and then press  .

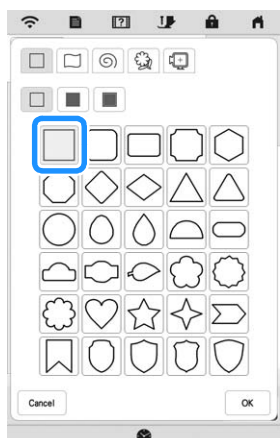

4 Press  .

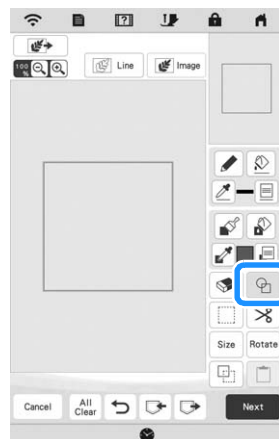

5 Select the heart shape, and then press  .

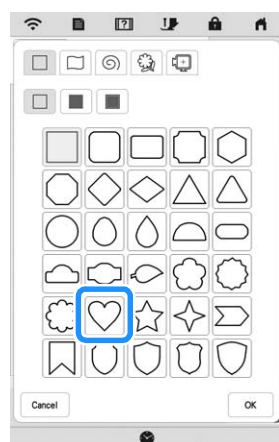

6 Press  .

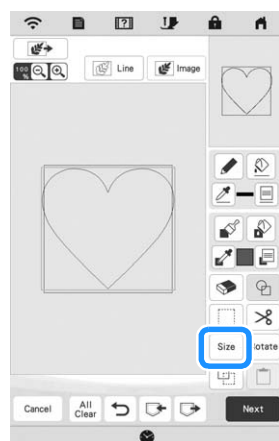

7 Press until the heart shape fits in the square shape, and then press .

8 Press , and then press .

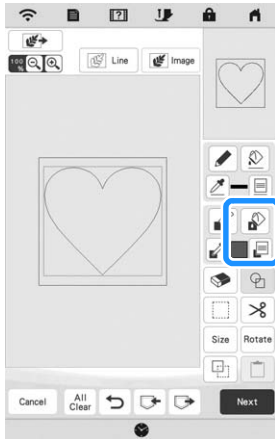

9 Press , and then select the stitch color. Press after setting the color.

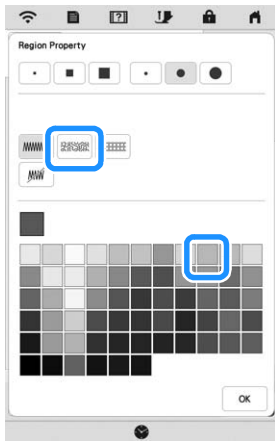

10 Select the region you want to set stippling effect.

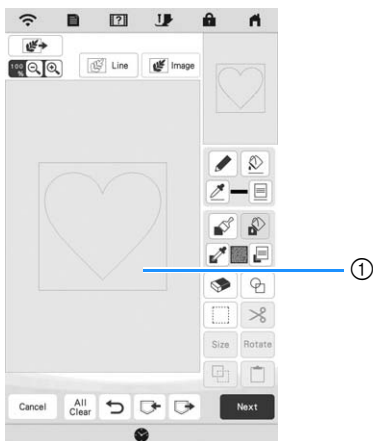

① Select this region.

11 Press .

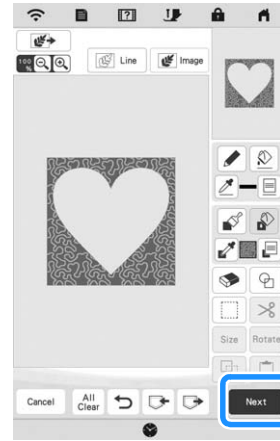

12 Adjust the stippling stitch settings to create the desired effect, and then press .

* For details, refer to "Specifying Individual Stitch Settings" on page 92.

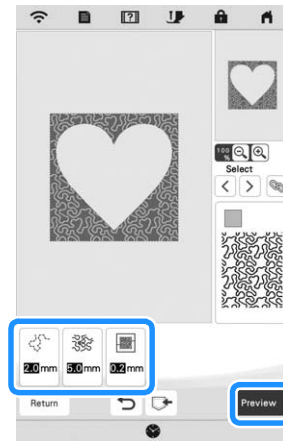

→ When the following message appears, press .



13 Press **Set** to convert into embroidery.

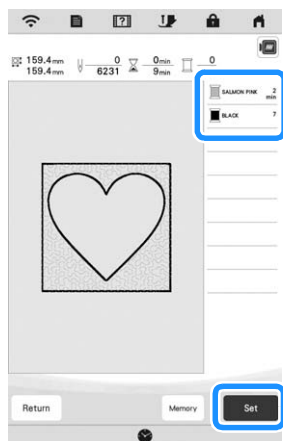

→ When the following message appears, press **OK**.

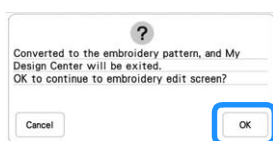



14 Follow the procedure described on "EDITING PATTERNS" on page 42 to edit the pattern as desired.

Decorative Stitching around a Pattern in Embroidery (a Quilting Function)

Memo

- For best results, reduce the embroidery speed. (page 17)

A quilt can be created with stippling stitch around an embroidery pattern.

- 1 Hoop the top layer of fabric in the embroidery frame, and then attach the frame to the machine.
- 2 Press  in the home page screen and select the pattern that decorative stitching will be added around, and then press  in the embroidery edit screen.

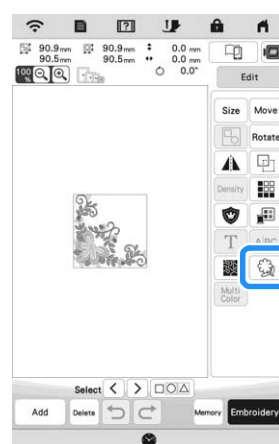

→ The outline of the pattern is displayed.

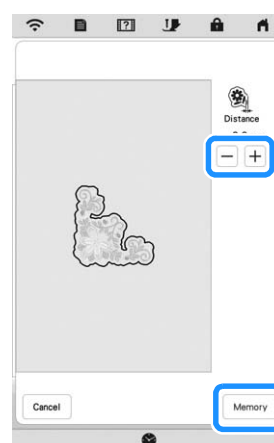

3 Set the distance and press **Memory**.



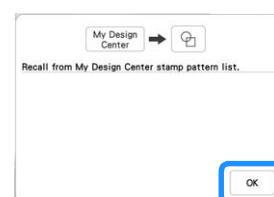

→ A message appears, and the pattern outline is registered as a stamp shape in My Design Center.

Press **OK**.



- 4 Press **Embroidery** to continue to the embroidery screen, and then embroider the pattern at the center.
- 5 Remove the embroidery frame from the carriage.
- 6 Photograph the embroidery frame with the application.
- 7 Attach the embroidery frame to the carriage again.
- 8 Place the batting and bottom layer of fabric under the embroidery frame.
- 9 Press  in the home page screen to start My Design Center.
- 10 Press  to load the embroidered fabric. Refer to "Loading the Background Image" on page 94 for details.



- 11 Press , press  to recall the stamp shape registered in step 3, and then arrange it over the loaded pattern.



- 12 Use a stamp or rectangular frame to determine the region to be stitched.

Note

- If the region is to be drawn by hand, be sure to draw a completely closed shape. If the region is not closed, it will not be correctly closed with any of the fill stitches.



- 13 Use the brush tool keys to select the stitch and color of the decorative stitching.



- 14 Fill the region to be stitched outside of the stamp shape outline.



- 15 Set the line type for the frame and pattern to , and then press **Next**.

* Stitch settings can be adjusted in the stitch settings screen. For details, refer to “STITCH SETTINGS SCREEN” on page 92.



- 16 Specify the stitch spacing and length in the stitch settings screen, and then press **Preview**.

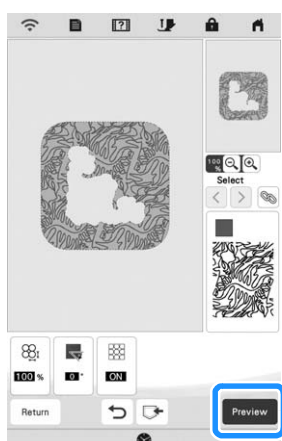

→ Check the pattern, and then press **Set**.



- 17 Embroider the stippling stitch around the embroidery pattern.



Chapter **5**
Appendix



CARE AND MAINTENANCE

⚠ CAUTION

- Be sure to unplug the machine before cleaning it. Otherwise, electric shock or injury may result.

If the surface of the machine is dirty, lightly soak a cloth in neutral detergent, squeeze it out firmly, and then wipe the surface of the machine. After cleaning it once with a damp cloth, wipe it again with a dry cloth.

If the screen is dirty, gently wipe it with a soft, dry cloth. Do not wipe the LCD screen with a damp cloth. Do not use organic solvents or detergents.

Restrictions on Oiling

In order to prevent damaging this machine, it must not be oiled by the user. This machine was manufactured with the necessary amount of oil applied to ensure correct operation, making periodic oiling unnecessary.

If problems occur, such as difficulty turning the handwheel or an unusual noise, immediately stop using the machine, and contact your authorized Brother dealer or the nearest Brother authorized service center.

Precautions on Storing the Machine

Do not store the machine in any of the locations described below, otherwise damage to the machine may result, for example, rust caused by condensation.

- * Exposed to extremely high temperatures
- * Exposed to extremely low temperatures
- * Exposed to extreme temperature changes
- * Exposed to high humidity or steam
- * Near a flame, heater or air conditioner
- * Outdoors or exposed to direct sunlight
- * Exposed to extremely dusty or oily environments

💡 Note

- In order to extend the life of this machine, periodically turn it on and use it. Storing this machine for an extended period of time without using it may reduce its efficiency.

Cleaning the Race

- 1 Press  (Needle position button) to raise the needle.
- 2 Turn the main power to OFF.
- 3 Remove the needle and presser foot (page 30, page 108).
- 4 Remove the bobbin cover.

- 5 Slide the needle plate cover toward you to remove it.

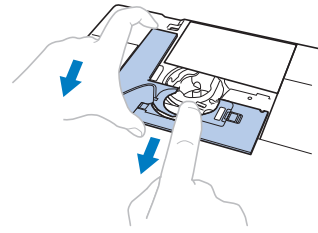

💡 Note

- If the embroidery unit is attached, the needle plate can be removed when the bobbin cover is removed.

- 6 Grasp the bobbin case, and then gently lift out.

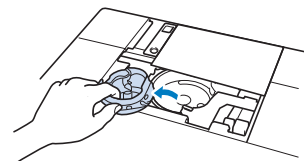

- 7 Use the cleaning brush or a vacuum cleaner to remove any lint and dust from the race and bobbin thread sensor and the surrounding area.

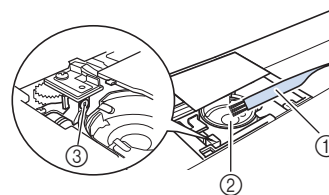

- ① Cleaning brush
- ② Race
- ③ Bobbin thread sensor

💡 Note

- Do not apply oil to the bobbin case.
- If lint or dust collects on the bobbin thread sensor, the sensor may not operate correctly.

- 8 Insert the bobbin case so that the ▲ mark on the bobbin case aligns with the ● mark on the machine.

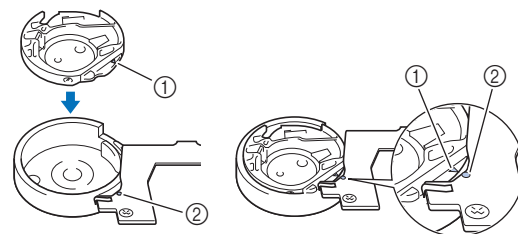

- * Align the ▲ and ● marks.

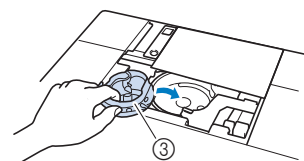

- ① ▲ mark
- ② ● mark
- ③ Bobbin case

- * Make sure that the indicated points are aligned before installing the bobbin case.

⚠ CAUTION

- Never use a bobbin case that is scratched, otherwise the upper thread may become tangled, the needle may break or machine performance may suffer. For a new bobbin case, contact your nearest Brother authorized service center.
- Be sure that the bobbin case is correctly installed, otherwise the needle may break.

- 9 Insert the tabs on the needle plate cover into the needle plate, and then slide the cover back on.

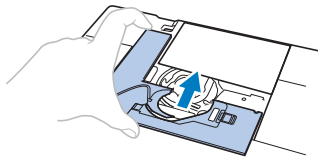

- 10 Reattach the bobbin cover.

Cleaning the Cutter in the Bobbin Case Area

The cutter below the needle plate should be cleaned. If dust or lint accumulate on the cutter, it will be difficult to cut the thread when  (Thread cutter button) is pressed or the automatic thread cutting function is used. Clean the cutter when the thread is not easily cut.

- 1 Follow steps 1 through 5 in "Cleaning the Race" to remove the needle plate cover.
- 2 Use the screwdriver included with the machine to unscrew and remove the needle plate.

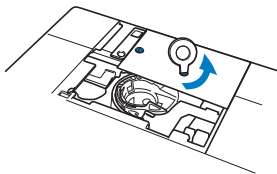

- 3 Use the cleaning brush or a vacuum cleaner to remove any lint and dust from the cutter in the bobbin case area.

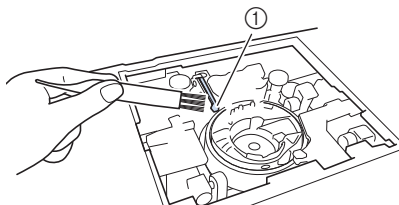

① Cutter

⚠ CAUTION

- Do not touch the cutter, otherwise injuries may result.

- 4 Align the two screw holes in the needle plate with the two holes at the needle plate mounting base, and then fit the needle plate onto the machine.
- 5 Lightly finger-tighten the screw on the right side of the needle plate. Then, use the screwdriver included to firmly tighten the screw on the left side. Finally, firmly tighten the screw on the right side.

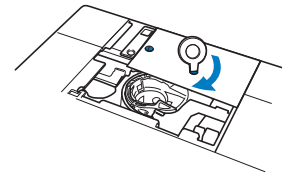



- 6 Replace the bobbin case and the needle plate cover following steps 8 through 10 in "Cleaning the Race".

Changing Embroidery Foot "W+" with LED Pointer

⚠ CAUTION

- When attaching an embroidery foot, always press  on the screen. You may accidentally press the "Start/Stop" button and possibly cause injury.
- Be sure to use embroidery foot "W+" with LED pointer when doing embroidery. Using another embroidery foot may cause the needle to strike the embroidery foot, causing the needle to bend or break and possibly cause injury.

- 1 Press  (Needle position button) to raise the needle.
- 2 Press  to lock all keys and buttons.
 - * If the message [OK to automatically lower the presser foot?] appears on the LCD screen, press  to continue.

Note

- Before replacing the needle, cover the hole in the needle plate with fabric or paper to prevent the needle from falling into the machine.

- 3 Raise the presser foot lever.
- 4 Remove the connector of the embroidery foot “W+” with LED pointer from the connector on the back of the machine.

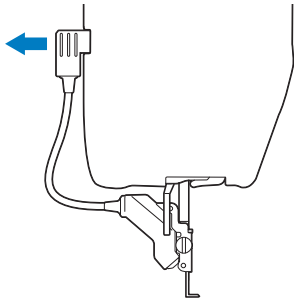

- 5 Use the included disc-shaped screwdriver to loosen the screw for the embroidery foot, and then remove the embroidery foot “W+” with LED pointer.

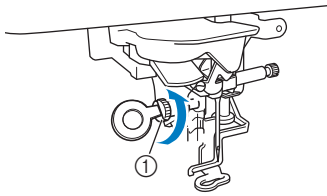

- 6 Position the embroidery foot “W+” with LED pointer on the presser foot bar by aligning the notch of the presser foot to the large screw.

Side view

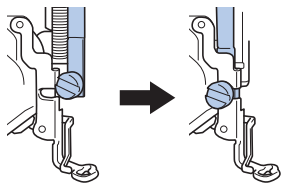

- 7 Hold the embroidery foot in place with your right hand, and then use the disc-shaped screwdriver to securely tighten the screw for the embroidery foot.

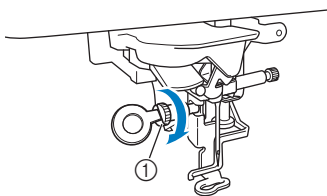



① Screw for embroidery foot

⚠ CAUTION

- Use the disc-shaped screwdriver to firmly tighten the screw for the embroidery foot. If the screw is loose, the needle may strike the embroidery foot and possibly cause injury.

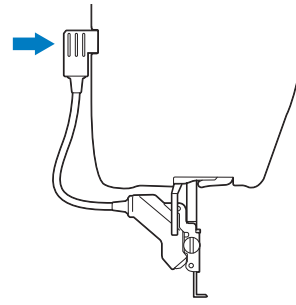
- 8 Plug the connector of the embroidery foot “W+” with LED pointer into the jack on the back left side of your machine.



- 9 Press  to unlock all keys and buttons.
→ All keys and operation buttons are unlocked, and the previous screen is displayed.

ADJUSTING THE SCREEN

Touch Panel is Malfunctioning

If the screen does not respond correctly when you touch a key (the machine does not perform the operation or performs a different operation), follow the steps below to make the proper adjustments.

- 1 Holding your finger on the screen, turn the main power switch to OFF and back to ON.



→ The touch panel adjustment screen appears.

- 2 Using the included touch pen, lightly touch the center of each +, in order from 1 to 13.

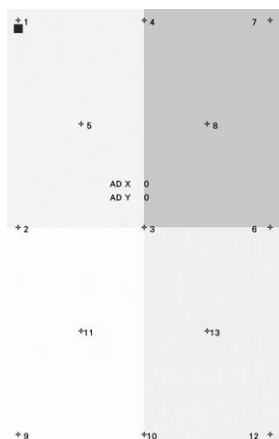

Note

- Only use the included touch pen to touch the screen. Do not use a mechanical pencil, pin, or other sharp object. Do not press too hard on the screen. Otherwise, damage may result.

- 3 Turn the main power to OFF, then turn it back to ON.

Note

- If you finish the screen adjustment and the screen still does not respond, or if you cannot do the adjustment, contact your authorized Brother dealer.

TROUBLESHOOTING

If the machine stops operating correctly, check the following possible problems before requesting service. You can solve most problems by yourself. If you need additional help, the Brother Solutions Center offers the latest FAQs and troubleshooting tips.

Visit us at “ <http://s.brother/cpeab/> ”.

If the problem persists, contact your authorized Brother dealer or the nearest Brother authorized service center.

Untangling Thread from beneath the Bobbin Winder Seat

If the bobbin winding starts when the thread is not passed through the pretension disk correctly, the thread may become tangled beneath the bobbin winder seat.

Wind off the thread according to the following procedure.

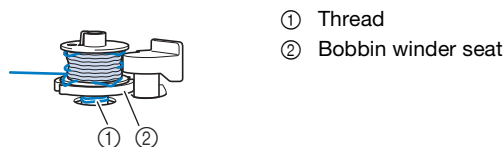

CAUTION

- Do not remove the bobbin winder seat even if the thread becomes tangled under the bobbin winder seat. It may result in injuries.

- 1 Press to stop the bobbin winding.

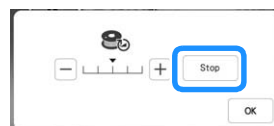

- 2 Cut the thread with scissors near the pretension disk.

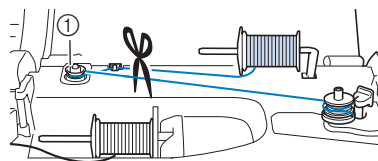

- ① Pretension disk

- 3 Push the bobbin winder switch to the right, and then raise the bobbin at least 10 cm (4 inches) from the shaft.

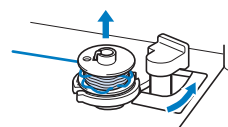

- 4** Cut the thread near the bobbin to completely remove the bobbin from the shaft. Hold the thread end with your left hand, and wind off the thread clockwise from under the bobbin winder seat with your right hand as shown below.

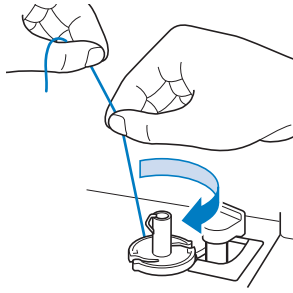



List of Symptoms

Check the following possible problems before requesting service. If the reference page is “*”, contact your authorized Brother dealer or the nearest Brother authorized service center.

■ Getting Ready

Symptom, Cause/solution	Reference
Cannot thread the needle.	
Needle is not in the correct position. • Press  (Needle position button) to raise the needle.	10
Needle is installed incorrectly.	30
Needle is turned, bent or the point is dull.	30
Upper threading is incorrect.	28
The needle threader hook is bent and does not pass through the eye of the needle.	*
The needle threader lever cannot be moved or returned to its original position.	*

Cannot lower the presser foot with the presser foot lever.	
Presser foot was raised using  (Presser foot lifter button). • Press  (Presser foot lifter button) to lower the presser foot.	10

Bobbin thread does not wind neatly on the bobbin.	
The thread is not passed through the bobbin winding thread guide correctly.	24
Bobbin spins slowly.	25
The thread that was pulled out was not wound onto the bobbin correctly.	24

Symptom, Cause/solution	Reference
The empty bobbin was not set on the pin properly.	23



While winding the bobbin, the bobbin thread was wound below the bobbin winder seat.	
You have not wound the bobbin thread properly when you initially wound thread on the bobbin. Ensure that the bobbin thread was properly set in the guides.	23

The bobbin thread cannot be pulled up.	
Needle is turned, bent or the point is dull.	30
Bobbin is set incorrectly.	26

Machine does not operate	
All keys and buttons have been locked by  .	30, 107

Nothing appears in the LCD.	
Main power switch is not turned on.	14
The plug of the power cord is not inserted into an electrical outlet.	14

The LCD screen does not look very clear.	
The brightness of the screen is not adjusted.	16

Nothing happens, even if the LCD display is pressed	
Adjust the screen.	108
The screen has been locked. • Press either of the following keys to unlock the screen.  	—

The LCD screen is fogged up.	
Condensation has formed on the LCD screen. • After a while, the cloudiness will disappear.	—

Embroidery unit does not operate.	
Embroidery unit is not attached correctly.	34
Embroidery frame was attached before the unit was initialized.	34

Symptom, Cause/solution	Reference
Pointer of the embroidery foot “W+” with LED pointer does not indicate the position correctly	
With thick elastic fabric, the position will be misaligned only at raised parts in the fabric.	59
With fabric having a very uneven surface, the position is not correctly aligned. <ul style="list-style-type: none"> The pointer indication should be used only as a reference. 	—

■ While Operating

Symptom, Cause/solution	Reference
Machine does not operate.	
“Start/Stop” button was not pressed.	10
Presser foot is not lowered.	10

Needle breaks.	
Needle is installed incorrectly.	30
Needle clamp screw is not tightened.	31
Needle is turned or bent.	30
Using improper needle, thread or the fabric prepared insufficiently for embroidering.	30, 55, 62
Upper thread tension is too tight.	73
Fabric is pulled during embroidering.	—
Spool cap is set incorrectly.	28
There are scratches around the opening in the presser foot.	*
There are scratches on the bobbin case.	*
Needle is defective.	30
A bobbin designed specifically for this machine is not being used.	23
Upper threading is incorrect.	28
Bobbin is set incorrectly.	26
Presser foot is attached incorrectly.	107
Stabilizer is not attached to fabric being embroidered.	55
Bobbin thread is incorrectly wound.	23

Upper thread breaks.	
Machine is not threaded correctly (used the wrong spool cap, spool cap is loose, the thread did not catch the needle bar threader, etc.)	28
Knotted or tangled thread is being used.	—
Upper thread tension is too tight.	73
Thread is twisted.	—

Symptom, Cause/solution	Reference
Needle is turned, bent or the point is dull.	30
Needle is installed incorrectly.	30
There are scratches around the opening in the presser foot.	*
There are scratches on the bobbin case.	*
Using improper needle or thread for the selected fabric.	30
A bobbin designed specifically for this machine is not being used.	23
Thread is weak, dry rotted, or of poor quality.	—

The thread is tangled on the wrong side of the fabric.	
Upper threading is incorrect.	28
Using improper needle or thread for the selected fabric.	30

The upper thread is too tight.	
The bobbin thread is incorrectly installed.	26

Bobbin thread breaks.	
Bobbin is set incorrectly.	26
Bobbin thread is incorrectly wound.	23
There are scratches on the bobbin or it doesn't rotate properly.	26
Thread is twisted.	—
A bobbin designed specifically for this machine is not being used.	23

Fabric puckers.	
There is a mistake in the upper or bobbin threading.	26, 28
Spool cap is set incorrectly.	28
Using improper needle or thread for the selected fabric.	30
Needle is turned, bent or the point is dull.	30
Thread tension is set incorrectly.	73
Fabric and stabilizer are not taut in the embroidery frame.	56
Incorrect or insufficient stabilizer is being used.	55

The pattern is not embroidered correctly.	
The thread tension is incorrect.	73
The thread is tangled, for example, in the bobbin case.	106

Symptom, Cause/solution	Reference
Skipped stitches	
Machine is threaded incorrectly.	28
Using improper needle, thread or the fabric prepared insufficiently for embroidering.	30, 55, 62
Needle is turned, bent or the point is dull.	30
Needle is installed incorrectly.	30
Needle is defective.	30
Dust or lint has collected under the needle plate.	106
Not embroidering	
Needle is turned, bent or the point is dull.	30
Bobbin is set incorrectly.	26
Upper threading is incorrect.	28

High-pitched sound while embroidering	
Needle is turned, bent or the point is dull.	30
Pieces of thread are caught in the race.	106
Upper threading is incorrect.	28
A bobbin designed specifically for this machine is not being used.	23
There are needle holes or friction scratches in the bobbin case.	106

The needle contacts the needle plate.	
The needle clamp screw is loose.	30
Needle is turned, bent or the point is dull.	30

The handwheel feels sluggish when it is turned.	
Thread is tangled in the bobbin case.	106

■ **After Finishing an Operation**





Symptom, Cause/solution	Reference
Thread tension is incorrect.	
Upper threading is incorrect.	28
Bobbin is set incorrectly.	26
Using improper needle, thread or the fabric prepared insufficiently for embroidering.	30, 55, 62
Thread tension is set incorrectly.	73
Bobbin thread is incorrectly wound.	23
Needle is turned, bent or the point is dull.	30
A bobbin designed specifically for this machine is not being used.	23

Symptom, Cause/solution	Reference
The pattern is not embroidered correctly.	
Thread is twisted.	—
Thread tension is set incorrectly.	73
Fabric was not inserted into the frame correctly (fabric was loose, etc.).	56
Stabilizing material was not attached. <ul style="list-style-type: none"> Always use stabilizing material, especially with stretch fabrics, lightweight fabrics, fabrics with a coarse weave, or fabrics that often cause pattern shrinkage. See your authorized Brother dealer for the proper stabilizer. 	55
There was an object placed near the machine, and the carriage or embroidery frame hit the object during embroidering.	34
Fabric outside the frame edges interferes with the arm, so the embroidery unit cannot move. <ul style="list-style-type: none"> Reinsert the fabric in the embroidery frame so that the excess fabric is away from the arm, and rotate the pattern 180 degrees. 	56
Fabric is too heavy, so the embroidery unit cannot move freely. <ul style="list-style-type: none"> Place a large thick book or similar object under the arm head to lightly lift the heavy side and keep it level. 	—
Fabric is hanging off the table. <ul style="list-style-type: none"> If the fabric is hanging off the table during embroidery, the embroidery unit will not move freely. Place the fabric so that it does not hang off the table or hold the fabric to keep it from dragging. 	62
Fabric is snagged or caught on something. <ul style="list-style-type: none"> Stop the machine and place the fabric so that it does not get caught or snagged. 	—
Embroidery frame was removed during embroidering (for example, to reset the bobbin). The presser foot was bumped or moved while removing or attaching the embroidery frame, or the embroidery unit was moved.	66
Stabilizer is incorrectly attached, for example, it is smaller than the embroidery frame.	55

Loops appear on the surface of the fabric when embroidering	
The thread tension is incorrectly set.	73
The tension of the upper thread is incorrectly set for the combination of the fabric, thread and pattern being used. <ul style="list-style-type: none"> Use the embroidery needle plate cover. 	62
The combination of the bobbin case and bobbin thread is incorrect.	62

ERROR MESSAGES

Below is an explanation of error messages. Refer to these when necessary (if you press  or do the operation correctly while the error message is displayed, the message disappears).

	Error messages	Cause/solution
1	Attach the embroidery frame.	This message is displayed when the machine is ready to embroider pattern, and the "Start/Stop" button is pushed while the embroidery frame is not attached.
2	Cannot change the configuration of the characters.	This message is displayed when there are too many characters and the curved character configuration is impossible.
3	Cannot embroider since the embroidery unit is not attached. Turn off the machine, and then attach the embroidery unit.	This message is displayed when the "Start/Stop" button is pushed and the machine is in embroidery mode, but the embroidery unit is not attached.
4	Cannot recognize the data for the selected pattern. The data may be corrupted.	This message is displayed when there is a possibility that the data for the selected pattern is corrupted.
5	Change to a larger embroidery frame.	This message is displayed when the machine is in embroidery mode and the small frame is attached, and the selected pattern does not fit in the small frame.
6	Check and rethread the upper thread.	This message is displayed when the upper thread is broken or not threaded correctly, and the "Start/Stop" button is pressed.
7	Failed to save file.	This message appears when you try to save more than 100 settings screen image files in the USB media. In this case, delete a file from the USB media or use different USB media.
8	Includes a special pattern that cannot be saved to external memory. Save the pattern in the machine's memory.	This message is displayed when you try to save a copyright protected pattern to USB media. According to copyright laws, patterns that are illegal to reproduce or edit cannot be saved to USB media. If this message displays, save the pattern in the machine's memory.
9	Lower the presser foot lever.	This message is displayed when  (Presser foot lifter button) is pushed while the presser foot lever is raised/the needle is lowered.
10	Make sure embroidery frame is moved as far back as possible. LOCK DOWN THE FRAME-SECURING LEVER.	This message is displayed when the embroidery frame is attached.
11	No more patterns can be added to this combination.	This message is displayed when you cannot combine patterns.
12	Not enough available memory to save the data. Delete some patterns or use a different media.	This message is displayed when the memory is full and the embroidery pattern cannot be saved.
13	Not enough available memory to save the pattern. Delete another pattern?	This message is displayed when the memory is full and the embroidery pattern cannot be saved.
14	OK to cancel the current pattern selection?	This message is displayed when, after selecting a pattern,  is pressed and the pattern is about to be deleted.
15	OK to delete the selected picture?	This message is displayed when the image is deleted.
16	OK to move the embroidery carriage to its previous position?	This message is displayed when replacing the embroidering bobbin thread.
17	OK to recall and resume previous memory?	This message appears if the machine is turned off while embroidering, then turned on again. Press  to return the machine to the condition (pattern position and number of stitches) when it was turned off. Follow the procedure described in "If the Thread Breaks or the Bobbin Runs out of Thread During Embroidering" on page 66 to align the needle position and embroider the remainder of the pattern.
18	OK to revert to previous color changes?	This message is displayed when  is pressed when changing thread colors.

	Error messages	Cause/solution
19	OK to separate the combined border pattern?	This message is displayed when rotating a saved combined pattern in the embroidery screen.
20	Pattern extends to the outside of embroidery frame.	This message is displayed when the machine is in embroidery mode, and the character pattern combination is too large to fit in the embroidery frame.
21	Pattern extends to the outside of embroidery frame. If you plan to add more patterns, rotate the pattern combination.	This message is displayed when the machine is in embroidery mode and the combined character pattern is too large for the embroidery frame. You can rotate the pattern 90 degrees and continue combining characters.
22	Preventive maintenance is recommended.	This message is displayed when the machine needs to be maintained. Once this message appears, it is recommended to take your machine to an authorized Brother dealer or the nearest Brother authorized service center for a regular maintenance check. Although this message will disappear and the machine will continue to function once you press <input type="button" value="OK"/> , the message will display several more times until the appropriate maintenance is performed.
23	Select a pattern.	This message is displayed when there is no embroidery pattern selected and the "Start/Stop" button is pressed.
24	Set the clock.	This message appears when the time/date is not set. Set time/date. (page 14)
25	The bobbin thread is almost empty.	This message is displayed when the bobbin thread is running out. Although a few stitches can be embroidered when the "Start/Stop" button is pressed, replace with a wound bobbin immediately. When embroidering, press  , press <input type="button" value="OK"/> , remove the embroidery frame, and then replace the bobbin with one wound with plenty of embroidery bobbin thread. If [Upper and Bobbin Thread Sensor] in the general settings screen of the machine setting mode is set to [OFF], this message does not appear.
26	The bobbin winder safety device has activated. Is the thread tangled?	This message is displayed when the bobbin is being wound, and the motor locks because the thread is tangled, etc.
27	The carriage of the embroidery unit will move. Keep your hands etc. away from the carriage.	This message is displayed when the embroidery unit is initializing.
28	The safety device was activated since the main shaft motor was heated. Is the thread tangled?	This message is displayed when the temperature of the motor increases, activating the safety device. Wait until the temperature decreases. If the error persists, contact your nearest authorized Brother dealer.
29	The safety device was activated since the main shaft motor seized. Is the thread tangled?	This message is displayed when the motor locks due to tangled thread or for other reasons related to thread delivery.
30	The safety device was activated since the needle position sensor malfunctioned.	This message is displayed when an error in the needle position sensor is detected, activating the safety device. Turn the machine off, then on again. If the message continues to appear, the machine may be damaged. Contact your nearest authorized Brother dealer.
31	The upper thread may not be threaded correctly. Thread the upper thread from the beginning.	This message is displayed when it seems that the upper thread has not been threaded correctly.
32	The USB media was changed. Do not change the USB media while it is being read.	This message is displayed when you attempt to select a pattern after the USB media in which the pattern is saved has been changed.
33	There is no needle plate cover. Attach a needle plate cover.	This message is displayed when the needle plate cover is not attached.
34	This editing function cannot be used when the pattern is out of the red outline. Use this function after moving the pattern.	This message is displayed when the machine is in embroidery edit mode, and you try to use an editing function when the pattern is not completely within the red outline.
35	This file cannot be used.	This message appears if the file format is incompatible with this machine. Check the list of compatible file formats. (page 116)
36	This file exceeds the data capacity and cannot be used. Use a suitable size file.	This message is displayed when the file size exceeds the data capacity of the machine. Confirm the file size and format. (page 116)
37	This key does not operate when the needle is down. Raise the needle and press the key again.	This message is displayed when a key on the LCD display is touched while the needle is in the down position.
38	This USB media cannot be used.	This message is displayed when you try to use incompatible media.

	Error messages	Cause/solution
39	This USB media is incompatible.	This message is displayed when you try to use incompatible USB media. For a list of compatible USB media, visit " http://s.brother/cpeab/ ".
40	USB media error	This message is displayed when an error occurs with the USB media.
41	Use the presser foot lifter button to lower the presser foot.	This message is displayed when a button, such as the "Start/Stop" button, is pushed while the presser foot is raised.
42	Use the presser foot lifter button to raise the presser foot.	This message is displayed when the embroidery unit is attached and the power is turned on with the needle in the down position.

■ Alarm Sounds

If the operation was performed incorrectly, an alarm sounds to indicate that an error occurred. If the operation was performed correctly, the machine beeps to confirm the operation.

Memo

- To cancel the operation beep or to change the volume, press  and then change the setting for [Machine Speaker Volume]. Refer to page 16 for more details.

SPECIFICATIONS

		Item	Specification
Size and Weight	Machine (Box 1 of 2)	Dimensions of machine	Approx. 612 mm (W) × 348 mm (H) × 321 mm (D) (approx. 24-3/32 inches (W) × 13-11/16 inches (H) × 12-5/8 inches (D))
		Dimensions of box	Approx. 740 mm (W) × 620 mm (H) × 405 mm (D) (approx. 29-1/8 inches (W) × 24-13/32 inches (H) × 15-15/16 inches (D))
		Weight of machine	Approx. 15 kg (approx. 33.1 lb)
		Weight of box (for shipping)	Approx. 25.5 kg (approx. 56.2 lb)
		Embroidering speed	70 to 1050 stitches per minute
		Needles	Home sewing machine needles (HA × 130)
	Embroidery Unit (Box 2 of 2)	Dimensions of embroidery unit	Approx. 595 mm (W) × 139 mm (H) × 524 mm (D) (approx. 23-7/16 inches (W) × 5-15/32 inches (H) × 20-5/8 inches (D))
		Dimensions of machine with embroidery unit attached	Approx. 916 mm (W) × 348 mm (H) × 524 mm (D) (approx. 36-1/16 inches (W) × 13-11/16 inches (H) × 20-5/8 inches (D))
		Dimensions of box	Approx. 735 mm (W) × 620 mm (H) × 190 mm (D) (approx. 28-15/16 inches (W) × 24-13/32 inches (H) × 7-15/32 inches (D))
		Weight of embroidery unit	Approx. 4.6 kg (approx. 10.1 lb)
		Weight of box (for shipping)	Approx. 6.8 kg (approx. 15.0 lb)
		Total Shipping Weight (Combination of all 2 boxes complete)	Approx. 32.7 kg (approx. 72.1 lb)
	Data Precaution	Memory	Embroidery patterns
Images can be imported to the machine (My Design Center)			100 MB
Data Types		Embroidery patterns ^{*1}	.pes .phc .phx .dst .pen
		Data that can be loaded when using My Design Center	.jpg .png .bmp
Types of USB Devices/ Media that can be Used ^{*2}		Embroidery patterns	Embroidery data can be saved to or recalled from USB media. Use media that meets the following specifications.
			<ul style="list-style-type: none"> • USB Flash drive (USB Flash memory) Embroidery data can be recalled only. <ul style="list-style-type: none"> • USB CD-ROM, CD-R, CD-RW drives You can also use the following types of USB media with the USB Memory Card Reader/USB card writer module. <ul style="list-style-type: none"> • Secure Digital (SD) Card • CompactFlash • Memory Stick • Smart Media • Multi Media Card (MMC) • xD-Picture Card

		Item		Specification
Condition of the [Eco Mode] and [Shutoff Support Mode]	[Eco Mode]	Available time	OFF, 10 - 120 (minute)	
		“Start/Stop” button	Green flashing	
		Suspended function	Machine light, Screen display, LED pointer	
		After recovering	The machine starts from the previous operation.	
	[Shutoff Support Mode]	Available time	OFF, 1 - 12 (hour)	
		“Start/Stop” button	Green slow flashing	
		Suspended function	All functions	
		After recovering	An error message appears. You need to turn off and on the machine to restart.	
Compatible image files of the Screen Saver Image	Format	JPEG format (.jpg)		
	File size	Max. 150 KB for each image		
	File dimension	1280 × 1280 pixels or less (If the width is between 800 and 1279 pixels, the image will be displayed at 800 pixels.)		
	Number allowed	5 or less		
Videos that can be played	MP4 file format	Video - H.264/MPEG-4 AVC, Audio – AAC		
	Size	450 (H) × 800 (W)		
	Maximum file size	1 GB		

- *1
- Using data other than that saved using our data design systems or this machine may cause this machine to malfunction. When the machine is used to save a file with any extension, it is saved as a .phx data file.
 - .dst data is displayed in the pattern list screen by file name (the actual image cannot be displayed). The full file name may not be displayed depending on the number of characters in the file name. Since Tajima (.dst) data does not contain specific thread color information, it is displayed with our default thread color sequence. Check the preview and change the thread colors as desired.
- *2
- USB media is commercially available, but some USB media may not be usable with this machine. Please visit our website “ <http://s.brother/cpeab/> ” for more details.
 - Depending on the type of USB devices/media being used, either directly plug the USB device into the machine’s USB port or plug the USB media Reader/Writer into the machine’s USB port.
 - * Please be aware that some specifications may change without notice.

CAUTION

- When using embroidery data other than our original patterns, the thread or needle may break when embroidering with a stitch density that is too fine or when embroidering three or more overlapping stitches. In that case, use one of our original data design systems to edit the embroidery data.

UPGRADING YOUR MACHINE'S SOFTWARE

You can use USB media to upgrade software for your machine.

When an upgrade program is available on "<http://s.brother/cpeab/>", please download the files following the instructions on the website and steps below.

Note

- When using USB media to upgrade the software, check that no data other than the upgrade file is saved on the USB media being used before starting to upgrade.

1 While pressing  (Automatic threading button), turn the main power to ON.

2 Press .

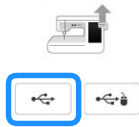

3 Insert the USB media into the primary (top) USB port on the machine.

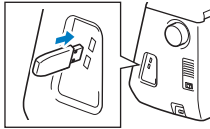

4 Press .

→ When upgrading is finished, the completion message appears.

5 Turn the machine off, remove the USB media, and turn the machine on again.

INDEX

A

Accessories	
options	13
Air vent	10
Alarm sounds	115
Alphabet characters	
embroidery	38
Appliqué	
using an embroidery frame pattern	81
Automatic threading button	10, 28

B

Bobbin	
setting	26
winding	23
Bobbin case	
cleaning	106
Bobbin cover	10
Bobbin threading	
setting the bobbin	26
winding the bobbin	23
Bobbin winder	10
Bobbin winding switch	25
Border key	45, 47

C

Cleaning	
race	106
Clock	14
Color shuffling function	50

E

Eco mode	17
Editing	
embroidery edit	42
Embroidery	
adjusting the speed	77
automatic thread cutting function (End color trim)	76
key functions	54
resuming embroidery after turning off the power	67
selecting patterns	36
thread color display	77
thread trimming function (Jump stitch trim)	76
Embroidery appliqué	64
Embroidery edit	
changing the thread color	49
key functions	42
repeated patterns	45
Embroidery foot "W+" with LED pointer	107
Embroidery frames	
attaching	58
inserting fabric	56
removing	58
types	56
using the embroidery sheet	57
Embroidery needle plate cover	62
Embroidery patterns	
checking the position	61
editing	42
embroidering	62
linked characters	78
retrieving	80
saving	80
selecting	36
using a frame pattern to make an appliqué	81
Embroidery sheet	57

Embroidery unit	34
Error messages	113

F

Favorite color scheme	52
-----------------------	----

H

Handle	10
Handwheel	10
Home page screen	15

I

Image key	44
-----------	----

K

Key functions	
embroidery	54
embroidery edit	42

L

LCD screen	10, 15
light	16

M

Machine help key	19
Main power switch	10
Metallic thread	28
MPEG-4 (MP4) videos	20
My Design Center	86

N

Needle	
changing the needle	30
Needle bar thread guide	10
Needle plate	10
Needle position button	10

O

Operation buttons	10
-------------------	----

P

Power cord	14
Power cord receptacle	10
Presser foot code	53
Presser foot lever	10
Presser foot lifter button	10
Presser foot/Needle exchange key	30, 107
Pretension disk	10, 24, 26

R

Race	106
Repeated patterns	45
Retrieving	
embroidery patterns	80
machine's memory	80

S

Saving	
embroidery patterns	80

machine's memory 80

Screen saver 18

Screw for embroidery foot 10

Settings

- automatic thread cutting 76
- embroidery settings 17
- general settings 16
- machine settings key 16
- thread tension 73
- thread trimming 76

Shutoff support mode 17

Speaker 16

Specifications 116

Spool cap 10

Spool net 28

Spool pin 10

Stabilizer 55

Start/Stop button 10

Starting point key 78

Supplemental spool pin 10, 23

T

Terms of Use 5

Thread

- thread tension 73

Thread color display 77

Thread color palette 49

Thread cutter 10

Thread cutter button 10

Thread guide 10, 24, 26

Thread guide plate 10, 25

Thread marks 47

Touch pen 109

Trial key 61

Troubleshooting 109

Tutorial video 19

U

Upgrading 118

Upper threading

- using the Automatic threading button 28

USB mouse 23

USB port 10

Please visit us at <http://s.brother/cpeab/> where you can get product support and answers to frequently asked questions (FAQs).



Be sure to install the latest software.
A variety of functional improvements are being performed in the latest version.



Brother SupportCenter is a mobile app that provides the support information for your Brother product.

This machine is approved for use in the country of purchase only. Local Brother companies or their dealers will only support machines purchased in their own countries.